

SPIRICO M

An Electromagnetic-Etheric Systems Approach
to
Communications
with
Other Levels of Human Consciousness



TO: Director of Research, Metascience Foundation:

I understand that within 6 to 12 months following the April 6 Press Conference you may publish a supplement to the first edition of the SPIRICOM technical manual. My check here indicates my desire to be notified of such a supplement.

My check here indicates that I expect to do research in this field and would be willing to share my successes and failures with other researchers. (It is the nature of basic research that much of great value can be learned from the failures!) I would like to receive notification about the inauguration of such a newsletter and prefer English edition German edition .

The number on the cover of my SPIRICOM manual is _____

Name (Please print) _____

Street _____

City, State, ZIP _____

April 1982
You have waited very
patiently to learn more of the
"Muller Story"
With Love
George and Jeannette
Meeh

TO: Anyone Contemplating Developing Equipment to Converse with the "Dead":

A Word of CAUTION

■ Tens of thousands of hours spent over 25 years by hundreds of EVP (electronic voice phenomenon) researchers in Europe have clearly shown that some form of supplemental energy must be utilized to permit even individual words or short phrases to reach a level of audibility detectable even by a researcher with a highly acute sense of hearing.

■ Eleven years of effort by Metascience researchers has established that the energies involved in the different levels of the worlds of spirit are not a part of the electromagnetic spectrum as science presently knows it. To have any chance of sensing or detecting such energies it is necessary to create some means of coupling the spirit energies to the devices at our disposal — transceivers, speakers, microphones, tape recorders, oscilloscopes, etc. Hence it seems that some form of transformer, coupler or transducer must be utilized to serve as an interface between the energies of the "dead" and the energies used in our electronic devices.

■ Of the five different system design concepts explored by Metascience researchers, only one has so far resulted in prolonged, two-way, normal voice conversation. That system, which we call Mark IV, uses the energy input from 13 different audio tones in what seems to be a more effective and constant energy source than the miscellaneous energies used by EVP researchers past and present. It also seems to use the auric energy field of one of our technicians who is such an advanced psychic that his clairaudient and clairvoyant abilities have on occasion allowed him to converse with and see the "dead" person. His energies have, on at least one occasion, been utilized in a full body materialization of a spirit form. To date, our only extensive two-way conversations have been obtained when this technician is present in the room in which the equipment is located.

■ Because of the above fundamental factors, we caution that merely building equipment according to the diagram for Mark IV may result in a waste of effort and money unless there is some form of highly charged human energy field available for use in combination with the mixture of 13 audio tones.

■ In an effort to eliminate the need of a human energy field, three other types of transducers are already being investigated by Metascience Foundation researchers — electrically activated quartz crystal utilizing ultraviolet light, living plants and the plasma of an open flame. These are outlined in Chapter 10.

■ One of the principle reasons for releasing this technical manual now is to encourage you and other researchers throughout the world to use your inventive talents to explore and solve the many mysteries which still separate us from the desired quality of communication.



To those who think it is strange that we are not currently in communication with the spirit world, we offer this analogy. Two bicycle mechanics, the Wright Bros., showed on December 17, 1903 that it was possible for Man to fly with a powered vehicle -- even though their flight lasted only 12 seconds and covered only 160 feet. The plane crashed and it was many months before they were able to make further demonstrations to a waiting world.

Metascience researchers have shown that their primitive system succeeded in establishing actual voice communication with the so-called dead. We, like the Wright Bros. after their demonstration, are not "flying." The impatient public will just have to wait until we or you learn more about the technique of such instrumental communication. To encourage as many other experimenters as possible to tackle the problem, is the reason we decided to share our experiences with all researchers around the world who might be interested.

SPIRICOM

An Electromagnetic-Etheric Systems Approach to Communications
with other Levels of Human Consciousness

By

The Metascience Research Team

George W. Meek -- President and Director of Research,
Metascience Foundation, Inc., Franklin, N. C.

William J. O'Neil -- Inventor, Electronic Technician, Consultant
to Metascience Foundation, Inc.

Hans Heckmann -- Electronic Technician, Conrail, Philadelphia,
Pa., Consultant to Metascience Foundation, Inc.

Willard Cerney -- Electronic Technician, Pres. Marine Electronics
Service, Inc., Ft. Myers, Florida, Consultant to Metascience
Foundation, Inc.

Bruce Dapkey, Electronic Engineer and Mathematician, Franklin, N.C.,
Consultant to Metascience Foundation, Inc.

and

DR. GEORGE JEFFRIES MUELLER

A "Deceased" American Physicist

Life's Energy Fields
Vol. VII of a Series

Other Volumes in this Series:

Vol. I From Seance to Science (England)
From Enigma to Science (USA)

Vol. II Healers and the Healing Process

Vol. III After We Die, What Then?

Vol. IV As We See It From Here

Vol. V Collapse and Comeback

Vol. VI The Magic of Living Forever



PUBLICATIONS DIVISION

First Printing — February 1982

Second Printing — May 1982

Third Printing — August 1982

Inquiries should be addressed to:

METASCIENCE FOUNDATION

P. O. Box 617469

Orlando, FL 32861-7469

ISBN: 0-935436-05-7

Library of Congress Catalog Number

81-86482

Printed in the United States of America

This volume is affectionately dedicated to our fellow researcher



Dr. George Jeffries Mueller *

Departed his physical body May 31, 1967

First two-way voice contact via SPIRICOM April 16, 1980

*Photo, courtesy of
Archives of Cornell University

Background Information

GEORGE J. MUELLER, Ph.D.

Born September 1, 1906

Died May 31, 1967

LAST POSITION HELD

Associate professor of engineering and mathematics, Orange Coast College, Costa Mesa, Calif., 1964-1967.

ENGINEERING EXPERIENCE

Manager, research and development center, Cannon Electrical Co., Anaheim, Calif., 1962-1964.

Chief of development and planning, Nortronics Division, Northrop Corp., Anaheim, Calif., 1960-1962.

Senior staff member, Ramo-Wooldridge Division, Thompson Ramo Wooldridge, Inc., Canoga Park, Calif., 1959-1960.

Director of engineering, technical products division, Packard Bell Electronics Corp., Los Angeles, Calif., 1956-1959.

Chief, test support department, Ramo-Wooldridge Corp., Los Angeles, Calif., 1955-1956.

Consultant in engineering and physics, Douglas Aircraft Co., 1953-1955.

Technical director, Dumont Labs, Inc., Los Angeles, Calif., 1952-1953.

Supervisory physicist and chief, technical services division, Patrick Air Force Base, Fla., 1950-1952.

Physicist and chief, research laboratory, Picatinny Arsenal, Dover, N.J., 1935-1950.

ACADEMIC POSITIONS

Research fellow, Cornell University, Ithaca, N.Y., 1933-1935.

Physics instructor, Cornell University, Ithaca, N.Y., 1931-1933.

Physics teaching assistant, Cornell University, Ithaca, N.Y., 1929-1933.

EDUCATION

B.S.	Electrical Engineering	University of Wisconsin	1928
M.S.	Physics	Cornell University	1930
Ph.D.	Experimental Physics	Cornell University	1933

PUBLISHED WORK

Mueller, George J. Introduction to Electronics, 1947.

Also contributed to various professional journals in physics.

MEMBERSHIPS

Institute of Electrical and Electronics Engineering (Senior member)

American Association for the Advancement of Science

The Franklin Institute

Institute of Radio Engineers

The Physical Society

Society for Engineering Education

Society of Motion Picture and Television Engineers

C O N T E N T S

	<u>Page</u>
Photograph and Background-- Dr. Mueller	
A Very Unusual Notice Regarding Copyrights, Patents, Suppression and Harassment	6
Index of Illustrations	7
Preface	9
1. Early Studies	11
2. A Crossroads: In Search of a Theory -- The Necessity for a Pseudoscientific Approach	16
3. How Our Approach Differs from that of Other EVP Researchers	16
4. Mark I	21
5. Mark II	24
6. Mark III and Mark IV	29
Important UPDATE July 30 1982	41A - 41M
7. Mark V	42
8. Lessons from "Direct Voice"	46
9. Spirit Energies -- Their Nature and Problems for SPIRICOM Researchers	52
10. Guidelines for Further Research	63
Mark VI	65
Mark VII	67
Mark VIII	70
11. Results to Date	74
12. Potential Benefits	77
13. The Very Real Dangers (Of Operating SPIRICOM-type Equipment)	82
A Final Word to Fellow Researchers	90
A Note to Scientists	91
Let's Keep This Breakthrough in Perspective	92
Appendix	
A. Considerations Regarding the Ether	93
B. Information on the Subject of Direct Voice	96
C. Instances of Direct Voice in the Bible	99
Bibliography	100
Index	

A Very Unusual Notice Regarding
Copyrights, Patents, Suppression and Harassment

All researchers affiliated with Metascience Foundation during the ten years of world-wide study of problems and potentials of electronic communication with the so-called "dead" have shared a common goal. They want the fruit of their labors and financial contributions to be made freely available to people of all races all over the world.

Therefore, on their behalf I state that:

1. We have not filed for any patents in any countries on the many inventions represented by the equipment presented herein.
2. The material in this report has not been copyrighted.
3. The name SPIRICOM has not been trademarked.

But please note! Everything in the cosmos is energy of one sort or another, and although all energies can be used for good or for evil, it is our hope that the hundreds of individuals and organizations which will carry these developments forward in the decades ahead, will use them ONLY FOR THE GOOD OF ALL MANKIND.

If any individuals acting alone or as part of a corporate entity endeavor to use these inventions solely for money-making purposes, or to the detriment of any person, they are herewith forewarned: They should know that the first stop for them, after they sooner or later shed their physical bodies, will be at the bottom of the Lowest Astral Plane - as described on the Metascience diagram entitled, "In Our Father's House There are Many Mansions."

We are gradually waking up to the fact that our universe and all therein operates on an inexorable law of cause and effect. None can afford to scoff at the admonition, "As ye sow, so shall ye reap." And note carefully the contents of Chapter 13!

Any effort by any individual or organization to suppress or destroy the material contained herein will be useless, and any attempt to in any way harass or harm any of the Metascience research team will be pointless: the material contained herein has been distributed throughout the world to more than one thousand persons who are dedicated to the ultimate perfection of a clear, static-free, dependable system for communication with those persons now living in the higher worlds of spirit who desire to bring enlightenment to mankind.

George W. Meek
President and Director of Research
Metascience Foundation, Inc.

ILLUSTRATIONS

FIG.		PAGE
18 A & B	"The Nature of Man"	18
1	Mark I - Pictorial	22
2	Mark I - Schematic	22
3	Mark I - Photo	23
4	Mark II - Pictorial	24
5	Mark II - Schematic	25
6	Mark II - Pictorial	26
7	Mark II - Pictorial	26
8, 9, & 10	Oscilloscope Patterns	28
11	Mark IV - Schematic	32
12	Mark IV Tone Generator - Schematic	34
13	Mark IV Tone Generator - Pictorial	34
14	Mark IV RF Signal Generator	34
15	Mark V - "Gunnplexer"	42
16	Mark V - Schematic	44
17	Mark V - Photo	45
18	Flame Transducer	66
19	Visible and Invisible Vibrations	68
20	Living Plant as a Transducer	71
21	Telephone to Spirits (a cartoon)	72
22	Spiricom Laboratory (a cartoon)	73
23	Cosmic Cycle Chart	88

P R E F A C E

When the great innovation appears, it will almost certainly be in muddled, incomplete and confusing form. To the discoverer himself, it will be only half understood; to everybody else it will be a mystery. For any speculation which does not at first glance look crazy, there is no hope.

Niels Bohr

Bohr's keen insight would have been appreciated by Thomas A. Edison. When he created a device to make it possible for Man to permanently record his spoken words, he only dimly understood the spinoffs that would result in the next 100 years.

And Edison certainly mystified both laymen and scientists. A member of the French Academy of Science investigated Mr. Edison's new phonograph and then with confidence reported to his colleagues, "I have examined Mr. Edison's phonograph and can assure you that the effect is accomplished by ventriloquism."

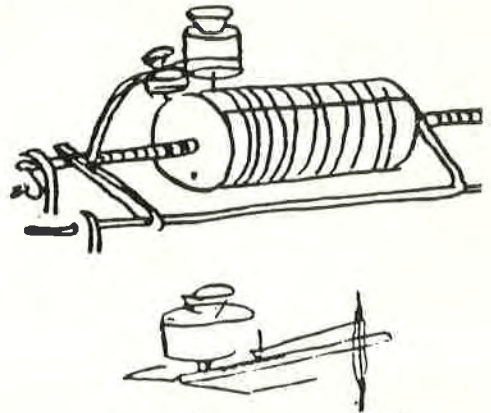

We few fellow mortals who have today created a crude device for instrumental communication with the so-called dead, are certain to be greeted by laymen and scientists with the same or even greater skepticism, disbelief and derision. We will reap charges of "ventriloquism" or other forms of hoax. The fact that the inventors of this "crazy" new system seem to have a somewhat muddled comprehension of the underlying laws of nature which must be involved, is also completely in line with Bohr's remarkably cogent insight.

With these preliminary thoughts on the record, we will spend no time refuting any accusations of fraud, hoax, or misinterpretation of results. We are quite content to leave judgment on all such matters to the unfolding of history in the 21st century.



The material which follows can be best understood and evaluated after the reader has studied certain theoretical constructs set forth in the booklet, **THE MAGIC OF LIVING FOREVER**, a diagram entitled, "In Our Father's House There are Many Mansions," and a cassette tape (or 12" long-play records) entitled, "SPIRICOM --Its Development & Potential."

These and other materials are available in a packet priced at \$10, postpaid in the USA. (All other countries \$11 surface mail or \$13 air mail, in US funds only.)

The same information may be obtained in a packet containing two 12" long-play records (instead of the tape) at \$11 postpaid in the USA. (All other countries \$12 surface mail or \$14 air mail, in US funds only.) Order from:

Metascience Foundation, Inc.
P. O. Box 747
Franklin, North Carolina 28734

EARLY STUDIES

For twenty five years researchers in many countries have suffered frustration and have often encountered ridicule in their work with the Electronic Voice Phenomenon -- EVP. Initially this euphemism was chosen partly for concealment because nobody wanted to use a name which indicated the possibility of anything so ridiculous as an electronic means to communicate with persons that had died and been buried or cremated! But with the passing years came a flood of books presenting evidence pointing to our survival of bodily death. And the researchers of EVP grew in numbers and in their determination to succeed.

The fact, reported here, that authenticated two-way voice communication (between a living person in the U.S.A. and a "dead" person) has taken place at intervals for more than two years, should begin to put an end to skepticism and ridicule. What is needed now is open-mindedness and a willingness by others to start serious research.

Needed also is wide dissemination -- at no profit -- of the basic facts of this breakthrough. Only by such action can numerous people in many countries quickly start to apply their talents to the problems which call for further attention, and by so doing, arrive at ultimate perfection of these and subsequent interplane communication systems. It is the purpose of this booklet to take the first step in such disclosure.*

Frequent trips to Europe by Meek in the early 1970's to observe research being done there showed that results from the various arrangements of tape recorders, microphones, diodes and radios had several things in common:

1. The "voices" were so faint that only a person with very acute hearing could detect anything at all.
2. Most of the sounds involved very few words.
3. The words were spoken very rapidly and often it was difficult to distinguish one word from the next.
4. The great amount of background sound (tape hiss, white noise, cross talk, hum, etc.) added to the difficulty of hearing. (The results of these four factors was that the

*The history of the pioneering efforts of Metascience Foundation, and portions of actual conversation with the "dead" are provided in the tape cassette and related materials mentioned on the opposite page.

The pioneering efforts of Friedrich Jurgenson of Sweden, Dr. Constantine Raudive and Theodore Rudolph of Germany, Franz Seidl of Austria, as well as Bayless, Welch, VonSzlay and others are reported in the bibliography at the close of this paper.

messages or phrases were so difficult to understand that if five people were listening, they might have five different opinions as to what was being said.)

5. Frequently even the shortest phrases would contain words from two or even three languages.
6. The content of the words or phrases often had no meaning or relevance for the listener.
7. There seemed to be little possibility of two-way meaningful conversation.

It was no wonder that the few parapsychologists who bothered to look into the work quickly lost all interest in the subject.

Moreover, very few of the persons feeling a desire to experiment in this field had any technical training, hence their work was confined to patiently spending many hours with ear phones, hoping they would hear some voices.

In view of these problems, Meek reached two basic conclusions upon completing his August 1975 trip to England, Germany, and Scandanavia.

Degree of Equipment Sophistication

The use of the diode as a white noise generator, the tape recorder, the microphone and the occasional use of radio frequency -- mostly in the kilohertz broadcast bands -- seems to have little chance of getting sustained two-way conversation, relatively undistorted and free from static.

Forty years earlier Thomas A. Edison, the American inventor with 1,090 patents to his credit, worked in the closing years of his life to invent an instrument to permit conversation with the dead. Referring to the table-tilting seances of his day, Edison observed, "Certain methods now in use are so crude, so childish, so unscientific, that it is amazing how so many rational human beings can take stock in them. If we ever do succeed in establishing communication with personalities which have left this present life, it certainly won't be through any of the childish contraptions which seem so silly to the scientist."

The equipment used in our lab in 1975 had obviously progressed beyond the "silly contraption" stage but it seemed clear to us that a far higher degree of instrumental sophistication would be required to reach the design objectives.

The Role and Nature of the Energies Involved

Obviously, the EVP devices mentioned above were operating at least in part in what we know as our electromagnetic spectrum.



Neither system uses electromagnetism in the strict sense; but they do use what is commonly known as EMF - electromotive force. This involves voltage potentials and current flows. The only basic electromagnetic energy in these two systems involves primarily the recording heads in the recorders and any transformers used.

But to what extent were other energies playing (or should they play) a role? Was it possible that on the levels of consciousness in which the deceased were living, there were types of energy of which our present sciences are unaware?

[A leading English scientist in 1975 wrote a book in which he flatly asserted that man and the cosmos could be fully explained by the four energies which science had already identified: electromagnetic, gravitational, nuclear and radioactive. He also assured the world that no energy existed that could travel faster than the speed of light. Now, only six years later, we know that he was wrong on both counts.]

It seemed to us that it would be necessary to carefully scrutinize the possible role of each of the following energies for a potential place in EVP research:

Generative

electricity
electric field (static)
gravity
electron charge (-)
brain waves
audible tones
etheric electricity (bioplasmic)
spirit energies

Radiative

Magnetism
magnetic field (induced)
radio activity
proton charge (+)
etheric magnetism
spirit energies

.....
A curious bit of news -

1-in-2 Americans receive messages from beyond the grave

NEARLY half of all Americans have received messages from beyond the grave, claims Dr. Richard Kalish of the California School of Professional Psychology in Berkeley.

But, Kalish says, some don't recognize the meaning of the message, and others cannot accept it as a genuine paranormal experience.

"These communications are not being received just by so-called mediums or psychics," Kalish says.

"They are normal, everyday people — waitresses,

housewives, students, plumbers and other professional people."

Kalish's conclusions support findings of a study at Cushing Hospital in Framingham, Massachusetts, in the mid-70s in which 63 of 140 subjects reported receiving messages from the deceased.

Dr. Robert Fulton of the Center for Death Education and Research at the University of Minnesota in Minneapolis says his own findings are amazing. "I was startled at a recent seminar when four of nine graduate students reported they had had contact with the dead," Fulton says.

From THE GLOBE Newspaper, January, 1982

... apparently NON-instrumental contact

with those living in the worlds of Spirit
is much more common than was known.

A CROSSROADS

In Search of a Theory -- Necessity for a Pseudoscience Approach

Considering the obvious complexity of the problem, our very limited manpower and financial resources, and our lack of understanding of what might exist in the way of energies outside the conventional spectrums as we know them, we were somewhat aghast at the scope of the task which we had set for ourselves.

Great advances in science generally do not require abandoning earlier hard-won theories. Rather they open up additional windows on the nature of reality. The SPIRICOM developments are no exception. We certainly do not wish nor attempt to invalidate our hard-won comprehension of the electromagnetic spectrum. However, to have any possibility of understanding the energies involved we must first expand our knowledge of the sea of ether in which we "all live and move and have our being" -- to use a phrase common in many of Man's religions. We must be willing to investigate and expand our knowledge of so-called psychic energies and energy fields-- such as those captured on color photographic film as shown in photos on pages 3 through 11 of the booklet, THE MAGIC OF LIVING FOREVER.

When we realize that all of these - the ether, psychic energy and the energy fields captured in these photos - are largely outside the boundaries of "establishment" science, it is obvious that our research and crude theoretical concepts may be brushed off as pseudoscience.

We find that our situation has a precise parallel to the predicament in which British plant physiologist Rupert Sheldrake found himself when, in 1981, he published A NEW SCIENCE OF LIFE. He proposed that all living systems are regulated not only by known energy and material factors but also by invisible organizing fields. He states that these fields are causative and serve as blueprints for form and behavior. "Establishment" science editorialized in the journal NATURE that the book was "an infuriating tract," and characterized its "misguided" author as one whose "knowledge should have enabled him to know better." It concluded that Sheldrake's book was "the best candidate for burning there has been for a long time."

Our decade of work investigating just such energy fields as Sheldrake reports, actually gave us a basis for tolerating at least some of the mysteries we encountered in our development of SPIRICOM.

The likelihood that this volume and its predecessor, Vol. VI, will be "candidates for burning" gives us no concern. Work which will be reported later in this book will be placed squarely on the pages of history. And those who attempt to give it the same treatment given Sheldrake's research, should know that at least a

scientist such as Bryan Josephson, Nobel prize winner in 1973, had this to say in the November 1981 issue of BRAIN MIND BULLETIN: (regarding NATURE's editorial)

A new kind of understanding of nature is now emerging, with concepts like implicate order and subject-dependent reality (and now, perhaps formative causation).

These developments have not yet penetrated to the leading journals. One can only hope that the editors will soon cease to obstruct this avenue of progress and instead encourage reviews of the field.

...You reject (the fields) as "pseudoscience" on the grounds that he does not prescribe their nature or origin, or discuss how their laws of propagation might be discovered. But the properties of heat, light and sound were investigated long before there was any understanding of their true nature, and electricity and magnetism originally had exactly the same status that you criticized...

You claim that hypotheses can be dignified as theories only if all aspects of them can be tested. Such a criterion would bar general relativity, the black hole and many other concepts of modern science from being regarded as legitimate scientific theories.

Josephson might also have observed that it sometimes takes establishment science a very long time to face up to a true breakthrough in knowledge. There is really nothing so new in Sheldrake's work. Dr. Harold Saxton Burr and Dr. F.S.C. Northrup of Yale University published their little-noticed paper, "Electrodynamic Theory of Life" in 1935. It reported the existence of organizing fields in plants and humans. The concepts in that paper and in later research by Dr. Burr did much to give us the insights and the courage to move into spirit communication research.

However, this small volume is in no sense an effort to set forth a new theory. It is primarily for the purpose of presenting to the world the fact that we in the flesh have communicated by means of an instrument with a person who has been dead for 14 years.

And we will not be at all concerned if it takes "science" some decades to satisfactorily explain how we did it!

HOW OUR APPROACH DIFFERS
FROM THAT OF
OTHER EVP RESEARCHERS

In the hope that it will be of considerable value to our esteemed fellow researchers, we here look back over our research efforts of the past decade, point out why we took a different approach from that made by other researchers, and then make available to them the fruits of our efforts.

1. We sought and received invaluable assistance from the persons with whom we wished to communicate.

Meek's numerous trips to Europe revealed what he felt was a one-sided approach to the problem. It seemed that researchers there gave no consideration to conditions that prevailed in the realms where the "dead" persons - their desired communicators - were living! There were many crucial questions that needed answers which could come only from the other side of life. Did the deceased possess any counterpart of the larynx? Was the communicator limited to generating and receiving mental energy, and if so did this mental energy fit into what science presently knows about the electromagnetic system? If not, what was the nature of these energies with which our sending and receiving equipment had to interface, in order to communicate in a really useful way? Was there any technique by which we could in some way communicate with persons in these realms so that we could discuss these and other questions?

From the earliest Biblical writings, literature has been filled with examples of communications from higher levels of consciousness to persons living out their daily lives on the surface of planet Earth. Traditionally such persons were called sages, seers, prophets or mystics. In this century the terms mediums, psychics, sensitives and telepathic channels have been used.

At the very beginning of our research (as will be explained in the next chapter) we had an unusual opportunity to come into contact with an American sensitive who seemed to have the possibility of putting us in touch with scientists now living on higher planes of existence. We were particularly interested in those scientists who wanted to join hands with us across the dimensions which separate them from us.

Putting it very simply, we wanted to rig a temporary "telephone" connection with some "dead" scientists until such time as we and they had successfully designed, built and tested an electronic system of some type. Hopefully, the equipment itself then or at a future time could be made to operate without any input from a psychic or mediumistic operator.

Having spent several years in full-time world-wide travel to meet and study healers, sensitives, psychics and mediums; and having carefully studied 100 years of literature dealing with such persons, Meek fully understood the dubious wisdom of such a

difficult undertaking! It was a case of looking for a needle in a haystack. Not one medium in a thousand possesses the various qualities to the degree needed for such an enterprise.

Someone once observed, "If you can't be smart, the next best thing is to be lucky." Now, as it will become obvious from results to be discussed later in this report, we have indeed been lucky.

2. We neither sought nor received major assistance from parapsychologists.

An intensive review of the literature indicated that in the first part of this century psychical researchers - and both the British and American psychical research societies - did much valuable work looking at the question of life after death. It was about the mid-point of the century when psychologists began to be seriously interested in psychical research. In the 60's they began to take over much of this research under the heading of parapsychology. In the 70's they more or less completed their takeover. In order to add respectability to parapsychology to the point where it could be considered a science, they almost completely avoided considering the possibility of life after death. Only in the early 70's when pioneers from medicine (Kubler-Ross and Moody) began to look at near-death experiences was there an awakening interest about life after death among a few of the parapsychologists.

We take the position that psychical research wound up with the wrong bedfellow. It was obvious to us in 1970 -- and even more so now -- that the marriage should have been made with a hard science--physics. And for two reasons:

First, it is now obvious that physics in the past 25 years has opened up windows on the nature of everything that exists in the cosmos. It has shown that every minute part of our physical body, as well as everything else, is energy in motion. The physicists at the forefront of the advances are saying that matter is mind-stuff, that everything exists in a seemingly UNlimited sea of MIND or CONSCIOUSNESS.

Second, it is equally obvious that psychology has undergone no expansion of a similar magnitude. Mental telepathy, out-of-body experiences, psychometry, clairaudience, clairvoyance, psychokinesis, materializations and apports are all psycho-energetic manifestations. Only a science which deals with energy can possibly unravel these mysteries.

When this situation is looked at realistically, it can be seen that the fantastically complicated mysteries of life and death have a better possibility for solution from the emerging science of paraphysics than from parapsychology. Hence, we neither sought nor received any major help or encouragement from parapsychology. Instead,

3. We concentrated on an engineering systems approach to the development of communications devices.

In view of what has just been said about our emerging realization that everything in the cosmos is energy of one form or another, it does not seem so strange that engineering talents have a place in creating the hardware needed to handle the energies involved in interplane communication. Most laymen never stop to consider that the hundreds of mechanical, electrical and communication devices they use daily have been created by engineers. The engineers are the ones who take the basic insights and convert them to practical everyday usefulness.

This viewpoint was well expressed by Tompkins and Bird in their book, THE SECRET LIFE OF PLANTS. The first paragraph of chapter 12, "Force Fields, Humans and Plants," reads:

Because their profession calls upon them for practical solutions to problems no matter how difficult they appear at first glance, engineers, unlike researchers in pure science, are less concerned with why or how something works than with whether it will work. This attitude frees them from the shackles of theory, which in the history of science has often caused pedants to disregard the brilliant new findings of geniuses because there was no theoretical basis to support them.

If ever a situation called for a practical solution, even though there is no supporting theoretical base, it is certainly that of creating an interplane communications system. The team of fellow researchers assembled under the Metascience Foundation banner have collectively logged more than 200 man-years of engineering and related technical skills.

But it is still very comforting -- and more productive of results -- if there is some theory behind what the engineers and technicians are endeavoring to construct. So,

4. We made an in-depth study into the basic nature of Man.

Meek, in collaboration with physicians, physicists, surgeons, biologists, parapsychologists, psychical researchers, psychiatrists, hypnotherapists, clergy and others - in many countries - spent several years studying the whole subject of health and illness. The focal point of the study was to unravel just what was taking place between a patient and a healer, witchdoctor, shaman, medicine man, minister or Christian Science practitioner.

One of the most fruitful locations for this on-the-spot research was the rice fields of Luzon, the northern island in the Philippines. Here native Filipinos, with perhaps the equivalent of two years of grade school education, were serving successfully as healers of patients coming from all over the world.

One of the strangest situations we had to face was the statement by the healers that they obtained their knowledge of what was wrong with patients and how to treat them, from what they

this page intentionally left blank

AM I REALLY
LIKE THIS?



FIGURE 18 A

A CHALLENGING NEW CONCEPT OF "THE HUMAN BODY"

From the viewpoint of late 20th century science

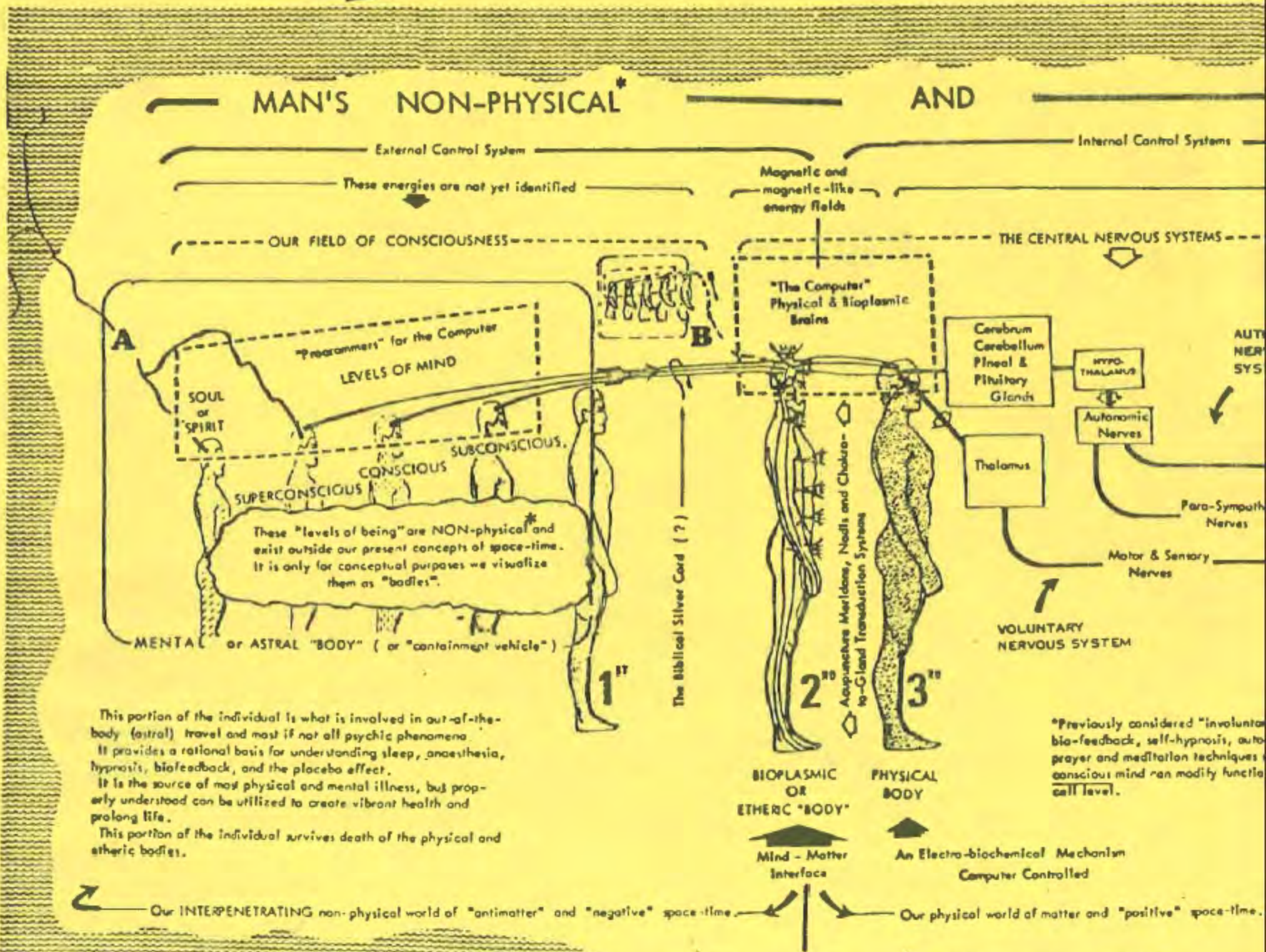

This portion of the individual is what is involved in out-of-the-body (astral) travel and most if not all psychic phenomena. It provides a rational basis for understanding sleep, anaesthesia, hypnosis, biofeedback, and the placebo effect. It is the source of most physical and mental illness, but properly understood can be utilized to create vibrant health and prolong life. This portion of the individual survives death of the physical and etheric bodies.

* By NON-physical we refer to energies which, as of today, are outside our knowledge of the four basic forces recognized by physicists.

Everything in this diagram is immersed in a "sea" of all prevailing energy which provides contact with everything else in the cosmos. In the past this energy has been referred to as ether, aether, etc.

FIGURE 18 A

CHALLENGING NEW CONCEPT OF "THE NATURE OF MAN"

Swampoint of late 20th century science and scientific mysticism

Copyright by Meek-Filler-McCauley

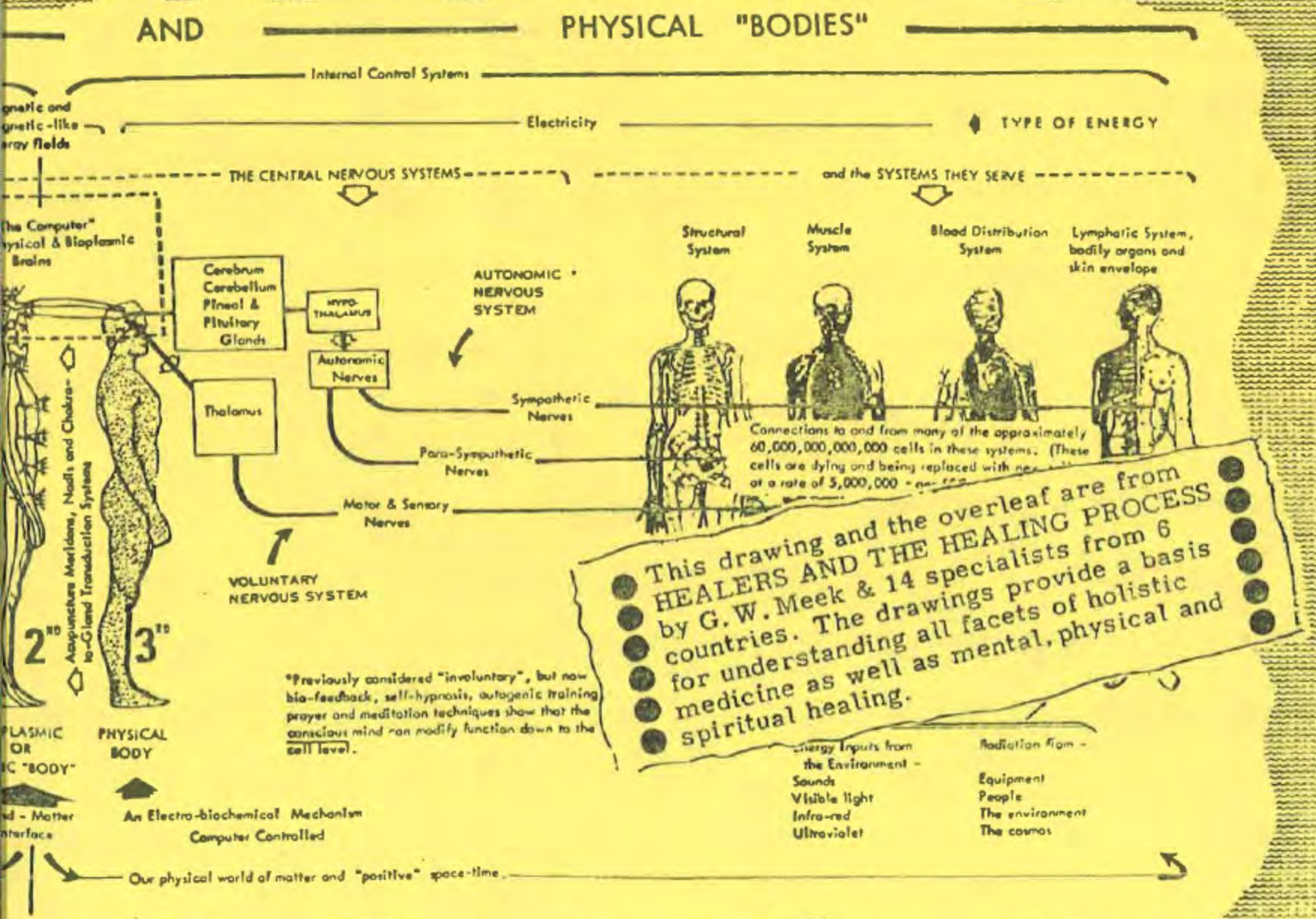

In the cosmos. In the past this energy has been referred to as ether, aether, aquna, prana, psi-matter, etc. We are now beginning to think of it in terms of an all-prevading sea of consciousness.

FIGURE 18 B

A CHALLENGING NEW CONCEPT OF "

From the viewpoint of the

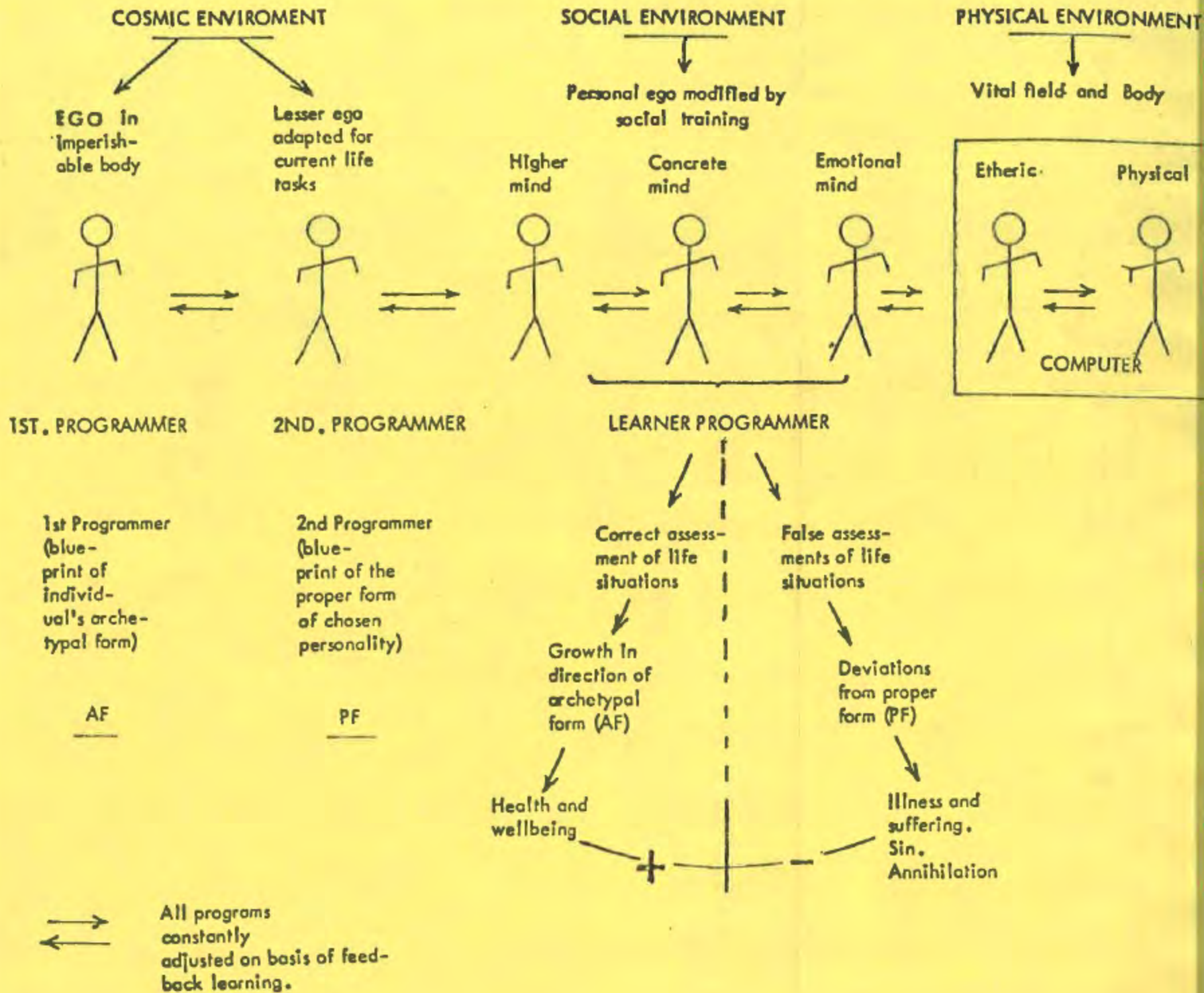
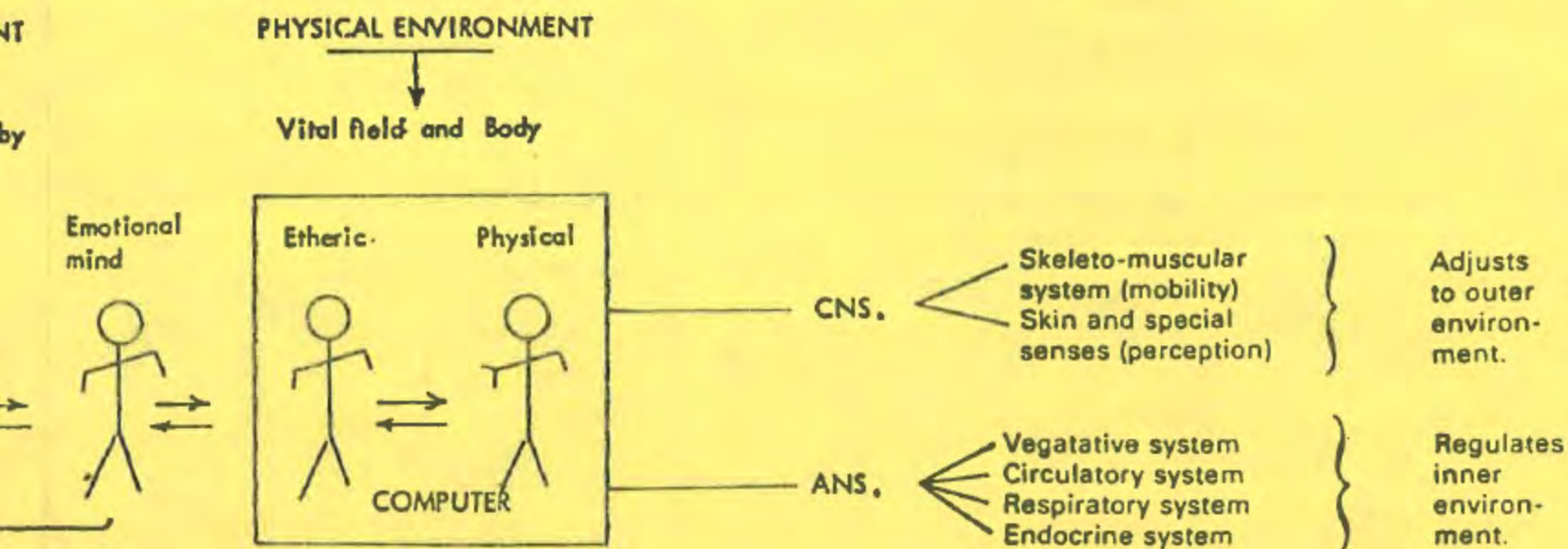

FIGURE 18 B

NEW CONCEPT OF "THE NATURE OF MAN"

from the viewpoint of the psychiatrist and parapsychologist



AMMER

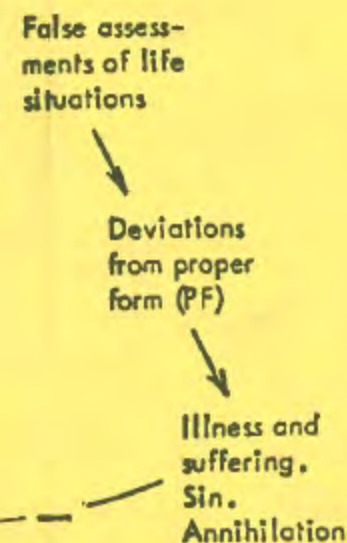

CNS—CENTRAL NERVOUS SYSTEM

Cerebrum

Telencephalon = cortex = new brain (self-awareness and control)
Diencephalon = older brain, major relay system, thalamus, pineal gland, hypothalamus and pituitary gland.

Cerebellum

Balance and coordination of cortico-spinal motor nerves; orientation via coordination of visual cues and cues from semi-circular canals in ears.

Brain Stem

Pons and medulla oblongata. Major lower relay station. Arousal centers.

Spinal Cord

Reflex nerve arcs and liaison with ANS.

ANS—AUTONOMIC NERVOUS SYSTEM

Spinal links, under the overall control of the diencephalon (see above)

variously called a guide, protector or spirit doctor who "spoke" to them inside their head! Were there really such persons alive in another dimension of reality? If so, had they carried over the knowledge gained as doctors when they were alive in a physical body? These and dozens of other fascinating questions are examined in the book HEALERS AND THE HEALING PROCESS, by 15 persons involved in these world-wide studies into the basic nature of Man.

Many of the insights from this research are assembled in the accompanying two diagrams taken from that book.

The chief point in Fig 18A that relates to our communication project is the block portion to the center left, labeled, "Mental or Astral Body." This indicates that we had come to the realization that a portion of Man exists outside our physical 3-dimensional world. It can travel - that is it can temporarily separate itself from the physical body - and apparently it can survive death of the physical body.

NOTE: Since it is a little too much to ask a psychiatrist or parapsychologist to be comfortable with terms like "energy fields," "non-physical energies," and "interpenetrating space-time systems," Mary Scott presented essentially the same concepts in Fig. 18B but with different terminology.

O.K., so we had learned at least a few useful things about the basic nature of Man, especially that some portion of him might very well wind up in heaven, hell, purgatory or some other realm of existence. If we were ever to communicate with occupants of such realms, could we possibly obtain a road atlas, tourist guide or travel handbook? We could and did.

5. We explored and mapped the realm in which our intended communicators now live.

We in the Western world, are, for the most part, familiar with the statement by Jesus of Nazareth, "In our Father's house there are many mansions." Was this just a nice poetical figure of speech or did it have some basis in fact? He frequently stated that life was eternal. Was this a snare and delusion? His follower, the Apostle Paul, said that Man had a physical body AND a spiritual body. Was this spiritual body a reality, and if so, what could it be?

In section one above we mention that we decided at the very start of our research to get into communication with kindly souls alive and well on the other side of the door marked "death." We did just that and reaped a tremendous harvest of information. Much of this material is reported in AFTER WE DIE, WHAT THEN? and AS WE SEE IT FROM HERE (both available from Metascience Foundation, as is also the book mentioned in (4) above.)

Based on perhaps 200 hours of such contacts, we assembled the road map shown in the large colored chart labeled, "In Our Father's House There are Many Mansions."

Here at last we had a growing understanding of the realms with which we were trying to communicate. Engineers by nature are

detailed, precise and visually minded. In the just-mentioned diagram we at last had a blueprint or floor plan of the many different rooms or "mansions." Moreover, we had some very specific knowledge as to just what was going on in the different areas or "mansions" and the type of individuals with whom we might possibly come in contact via such instruments as we could devise. While we started out concentrating on the higher spiritual planes, we found our best instrumental contact to date has been on lower levels.

Being of an inquisitive nature, we next posed the question, "Would it ever be possible to photograph the energy fields of which some of the inhabitants of these realms most likely are composed?"

6. We are conducting research in the field of etheric photography.

There is little that we care to report at the time this material is being assembled for printing. However, some insights as to what may be possible is shown by photographs from the early stages of research on pages 5 through 11 of the small volume entitled THE MAGIC OF LIVING FOREVER.

The foregoing six items show wherein our approach to inter-plane communication has differed from most other research in the EVP field. Our different approach paid off wonderfully well for us. On October 17, 1977 we had our first crude two-way conversation with a deceased American medical doctor, a former "ham" radio operator.

In April, 1980, we enjoyed our second breakthrough with the help of Dr. George Jeffries Mueller, an American scientist who departed his physical body May 31, 1967.

Since this volume is prepared primarily for those interested in the technical aspects of communication, we will, without further background information, proceed to present a detailed step-by-step account of our decade of building, testing and rejecting various pieces of equipment.

We present this detailed material to our fellow researchers all over the world in the hope that it will give them insights which will quickly make their approach to research much more productive.

By helping to someday perfect a workable and dependable communication system for contact with the mental and causal plane, they will perhaps contribute to the welfare of the average man far more than have the billions of dollars spent to put Man on the moon.

We will discuss the potential benefits - and dangers - later.

300 MHz 1972-1973

In late 1970, Meek returned from a trip to Europe where he had made his first investigation of EVP. Shortly thereafter he was approached by a man with the news that a deceased British-born scientist, who had died in 1962, had communicated through a medium and said he would like to work with qualified engineers interested in developing a communication system. Meek investigated the situation and came in contact with this scientist, Dr. William Francis Gray Swann. Dr. Swann had impeccable qualifications, having been chief physicist at the Carnegie Institution, a physics professor at Yale, and having contributed to the study of cosmic rays, atomic structure, relativity and atmospheric electricity. He was author of "The Architecture of the Universe."

A small laboratory was established. Hans Heckmann became a part of the newly formed team which chose the name Meta-science Associates.

Even at this early stage we realized that no one or two fields of science had any possibility of providing the knowledge we would need to carry through such an undertaking. We chose the prefix "meta" because of its dictionary meaning of "over, beyond and transcending..." ALL fields of science and allowing room for inclusion of metaphysics and the best of the religious and esoteric lore of the ages. We are of the opinion that many of the needed insights do not exist in any libraries of the world.

Heckmann's knowledge of German made it convenient to correspond with Theodore Rudolph who was doing EVP work in Germany and Franz Seidl who was doing similar research in Austria. Heckmann and Meek then began an intensive research activity looking toward the design of equipment to serve as our first prototype - Mark I.

The method we chose almost suggested itself. There was no desire to contact the lower and middle astral levels of spiritual life. Since our spirit contactees resided in an area of higher vibrations, the so-called mental and causal level, we could not consider low vibrational approaches. We decided to use a high frequency generator that would provide a "carrier" wave. This method had been somewhat neglected by EVP researchers but seemed most promising for our intentions.

The major problem with voice communication has been the weakness of the recorded voices. This is particularly true when these voices are barely audible above the atmospheric noise, inter-station hash or program material of radio stations (radio and diode method), or background noise (when using microphone method). We hoped to avoid this by using a totally shielded transmitting/receiving system. (A Faraday cage is no barrier to mental, psychic or spiritual energies.) Any kind of spirit interaction was expected to take

place in that area. We obtained several good surplus generators and during the summer of 1973 Hans built our first communication prototype. (Fig. 1 & 2).

The signal output of a 300 MHz generator was coupled to a 5½ foot long antenna which consisted of three parallel copper wires. Two of these wires radiated the generator signal while the center wire picked up the capacitively and inductively coupled signal and fed it into a demodulator. Antenna and generator signal were adjusted for resonance.

If a voice modulation took place it would be so small and weak that a conventional diode detector would hardly recover it.* Anyone familiar with the poor performance at the "knee" of a diode will understand. A more sensitive demodulator had to be used. We settled for a RF transistor with a 600 MHz bandwidth.

The transistor was operated in a saturated condition in a detector circuit making this device a very sensitive demodulator. Audio amplification took place in a battery-powered, low-noise op-amp type preamplifier. Another op-amp type 540 provided the high-level audio signal for the tape recorder and was also driving several headphones for monitoring.

*Exceptions are the Schottky Barrier Diodes, which make excellent detectors.

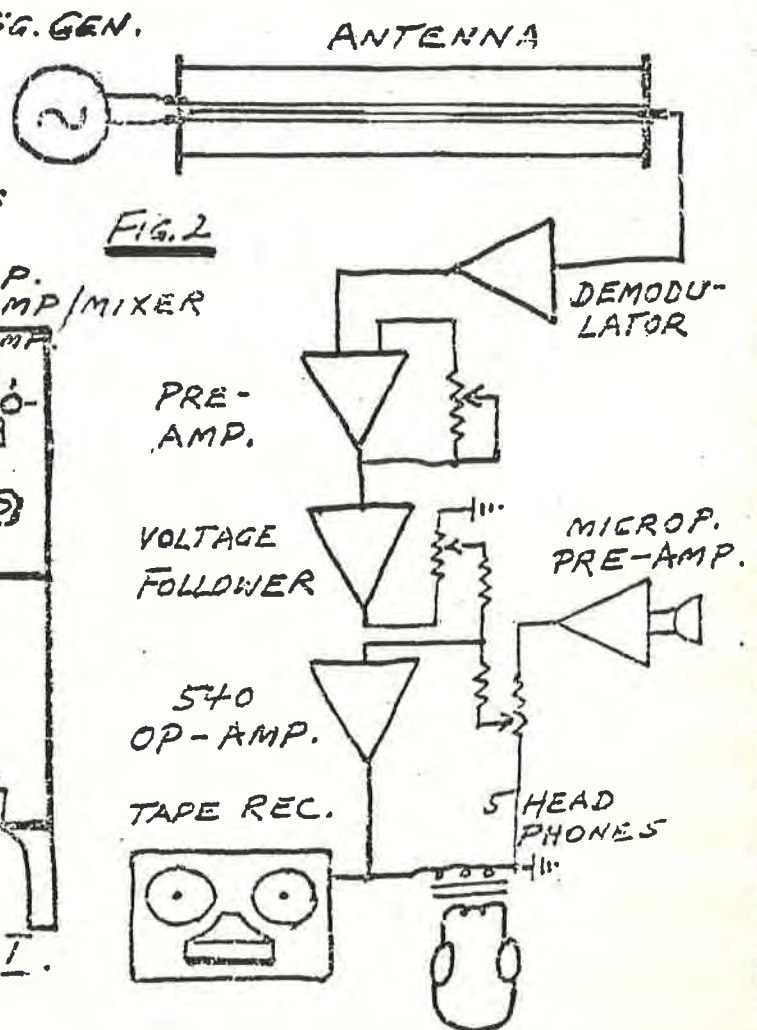
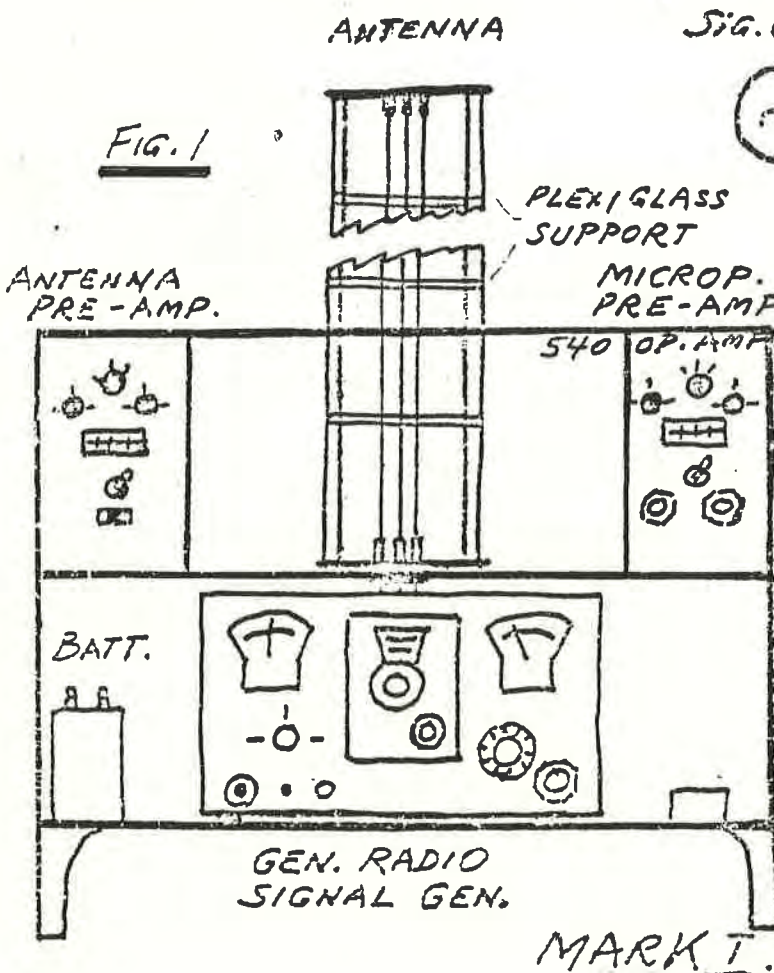

Mark I was first used during two sessions with a trance medium in our small new lab near Philadelphia. This gave us the advantage of getting immediate reaction and feedback from our spirit collaborators. The task of finding our signal was described as "hitting a small target far out in the ocean with a rifle bullet." However, Dr. Swann did pinpoint the signal very shortly and left his own audible 1 KHz impingement on two of our tape recorders. It is interesting to note that one of these recorders was not connected to Mark I at all. Our generator signal was described as "wavering 5-10 MHz" -- 300 MHz was the highest frequency available to us. Even at that, Dr. Swann described through the medium's guide that he could only locate our signal by finding its higher harmonics which extended above 1000 MHz. No voice modulation was achieved and we were already planning a much improved Mark II.



Fig. 3

Meek and Heckmann discussing Mark I
1973

MARK II

1,200 MHz 1973 - 1977

Experiences with Mark I showed the necessity of:

1. A much more stable oscillator.
2. An oscillator of higher frequency and more power.
3. A more accurately tuned antenna with a better coupling efficiency between radiating and receiving antenna.
4. Maintaining shielded antenna for noise free operation.

Concept and Description of Mark II

Construction of Mark II started in July 1974. With the above guidelines in mind, we had ordered a new 1200 MHz microwave oscillator which was quite an improvement over the old model General Radio signal generator used for Mark I. The new unit was compact and extremely stable. Its power output of 2.5 watts was phase-locked. A temperature controlled crystal assured extremely close frequency tolerances.

An elliptical, totally enclosed, copper chamber was built (Fig. 4) with focii that were a half wavelength of the 1200 MHz signal.

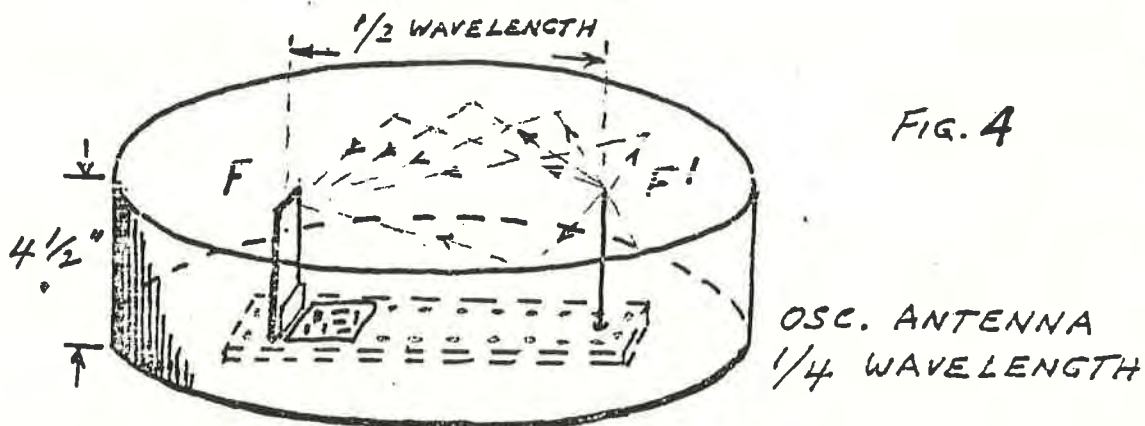

The oscillator antenna (1/4 wavelength stub) radiates the 1200 MHz signal into the chamber at focus point F'. At the other focus point F we have a 1/4 wavelength open section which acts as a parallel resonant section at the fixed 1200 MHz frequency. A miniature demodulation amplifier was designed which we installed at the base of this silver-plated section. The demodulator receives the signal by means of a small silver plate that is closely spaced and capacitively coupled to the 1/4 wavelength section.

The demodulator works in a circuit similar to the one used for Mark I. However, we used a Motorola type MM 4049 high speed switching transistor with a bandwidth of 4000 MHz and a current gain of more than 20. We installed the demod. inside the chamber to make sure anything picked up is turned into audio frequencies before

leaving the chamber. An RF filter feeds the audio modulations into a SWTP model 195 discrete operational amplifier which was modified to operate with a signal to noise ratio of better than 100 db and a variable gain of 40 to 1800.

Every effort was made to increase the efficiency of the copper chamber. The inside was silver plated for better reflectivity. Its elliptical shape offered a practical solution of maintaining some sort of phase relationship.

Due to the sensitivity of the apparatus and the high electronic amplification, outside traffic noises, especially from heavy trucks, were often acoustically coupled to the chamber and modulated the carrier signal. The entire apparatus therefore had to be acoustically insulated with foam rubber and by fibre cushioning on its top and bottom. Later the entire assembly was suspended from the ceiling on long rubber bands.

For most of the important early experiments we used a voltage regulated, low ripple power line supply. It was later replaced by a voltage regulated -24 volt rechargeable battery. The total absence of 60 Hz and 120 Hz hum made a worthwhile improvement which would have helped with the better recognition of early impingements.

Our lab was located 10 miles from the busy Philadelphia International Airport. We wanted to make sure our oscillator signal could not leak out of the chamber and perhaps interfere with air traffic communication. And there was always the F.C.C. who was looking out for offenders. The entire apparatus was therefore enclosed in a double copper screened cage and RF filters were installed for cables and power line entering it.

BLOCK DIAGR. MARK II

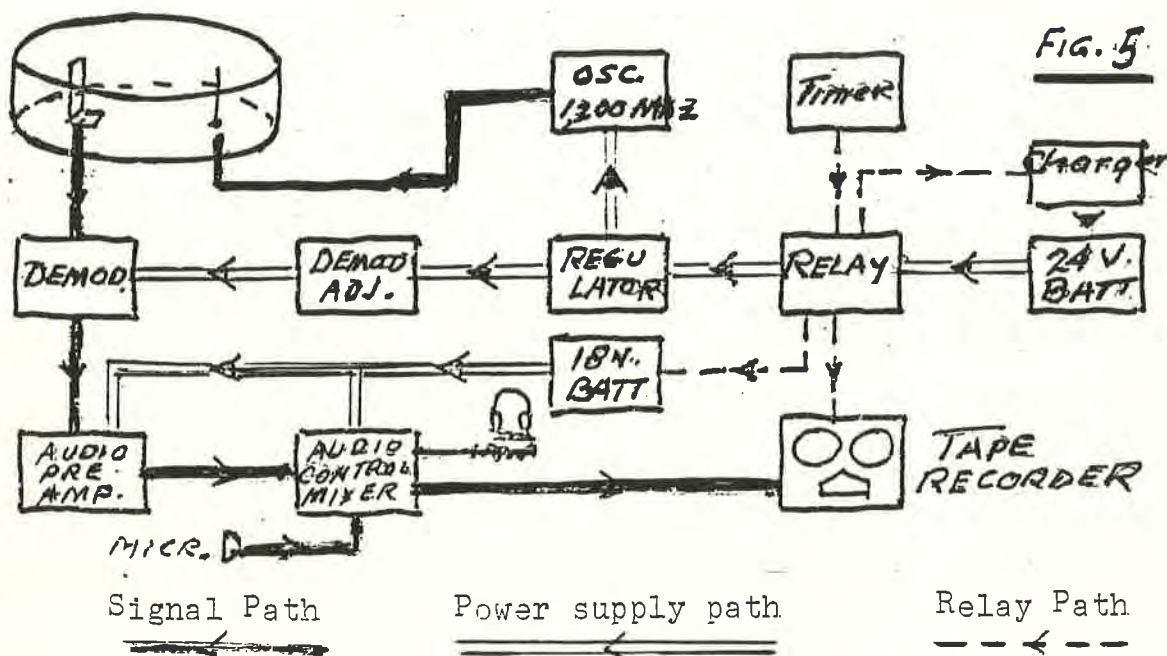



Fig. 6
Mark II in our
Philadelphia Lab
about 1975

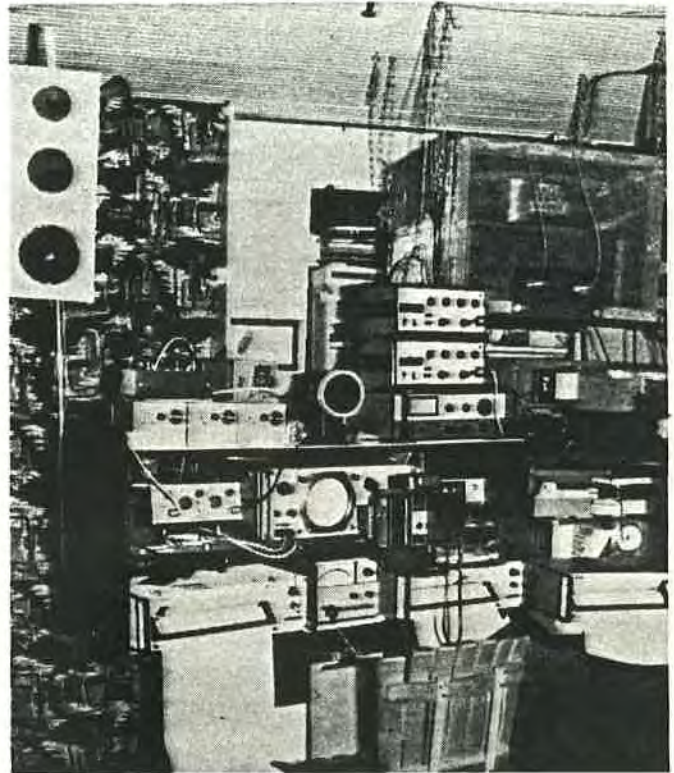

Fig. 7
Mark II (upper right)
In suspension mount in
the Florida Lab 1976

Mark II was first used during the Fall of 1974. Our sensitive, for personal reasons, was no longer available as a telepathic channel. Fortunately Meek, as a result of his wide-ranging search for such talent, was able to secure the assistance of another very fine telepathic channel.

It took two sessions for our small team and the new channel to get into attunement and establish contact with Dr. Swann. It was during these early attempts that we contacted an entity who was introduced as "Oppenheimer" (Dr. O., pioneer nuclear scientist). Some of his statements shed some light on the problem of penetrating higher dimensions with electro-magnetic energy. Quote:

Question: Can you sense this frequency that we are generating right now, the 1200 MHz in this energy chamber, can you sense this now? Oppenheimer: From the mark of about 1000 MHz we can sense and know. In other words, we see this in our world as a type of light which emanates from this source here and which in our world we not only see but feel. It is not as strong, as magnetic an attraction as we desire but it is a beginning, an excellent beginning. We can be attracted to this just as we are attracted to an open channel (medium) whose physical senses are stilled and who has what is known on earth as an abnormal arrangement of sensibilities. We can use the wavelength of the channel to communicate. This (device) you have set up here serves as such a wavelength of communication...Bear in mind that our dimension is interpenetrated with many types of energies from your world. And

these energies, consisting of lower forms, create what we call here the equivalent of your term static.

Upon contacting Dr. Swann we heard his first reaction to our Mark II setup. Quote:

Dr. Swann: We can only say this is a step in the right direction. The signal is not strong enough as we see it, but much more steady than before. We cannot yet maintain a test signal. Unquote.

At the end of this now historic session, the medium's guide, Samarka, had a few encouraging words: Quote:

Samarka: The main purpose here is to use this machine. Use it again and again. We cannot find the bugs, if there are any, without using it. The signal appears to grow somewhat, the longer the session has lasted...It is up, over and above the normal vibrational static we receive from such energies as television, radio, electrical machinery of all sorts, radar and all of these things. This is a better, stronger and purer type signal than we have had before in this area. We want to use it. We want to work with it. Unquote.

The next day plans were made for giving our friends ample time and opportunities to work with Mark II. It was agreed to operate the instrument regularly in the early morning hours between 4:00 and 4:30 A.M., these being the hours of least interference.

The apparatus was left unattended during the nights and controlled by a timer. Also a monitor tape recorder was automatically turned on and off.

Our friends did not succeed in impinging intelligible voices on our carrier signal but manifested themselves through various audible phenomena such as:

1. Low frequency impingements of individual sine waves of about 7-8 millisecond duration (150-130Hz) arriving with various spaced intervals, sometimes in rapid succession. It was most unusual to see these sine waves end abruptly at the base line without tapering out. We believe that this modulation was produced when our friends "cut" through our 1200 MHz carrier with their spiritual energy.* At the moment of interception (the null) a distinct sinusoidal modulation resulted.

The experiments further showed that our collaborators were not able to sustain this interaction with our microwave "beam" continuously and at a constant level. Our audio tapes contain impingements that range from intermittent sounds (approx. 150Hz freq.) to a string of these sounds. The repetition rate of some of these was slow at first, rapidly increased and trailed off. (See Fig. 8).

*See further explanations about these energies in Chapter 9.

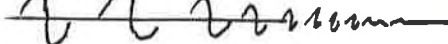
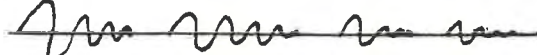
Fig. 8 Fig. 9 Fig. 10 

These results were confirmed by Dr. Swann's remarks in the June 30, 1979 session:

Dr. Swann: We know that we can project the energy. We do not know how long nor how continuous we can do this. So far most of our tests have shown that this energy emerges in spurts and more or less as a "jumping forward" and then being subject to the laws of inertia begins to lapse before it builds up its forward movement again.

Figure 9 shows the oscilloscope view of such a string of impingements.

During the first few months while we were getting intermittent impingements we also picked up acoustically coupled rumbling noises from our chamber. These sounds at times would be modulations.

2. We found several monitor tapes where portions of the familiar residual equipment noise was erased (together with what may have been impinged on carrier and tape). An explanation was given by Dr. S, much later. He admitted to erasing the tape portions because his group had not been satisfied with the results and they decided to erase it. I never quite understood their reasoning.
3. Dr. Swann's group made some partially successful attempts of transmitting pulse coded words by using the modulations described under No. 1. However, they arrived too rapidly for word recognition and the low rumble (see above) at that time was interfering too much to recover the word pulses by electronic means.

In those early days we made no provision for two-way communication. (Alexander Graham Bell's first telephone was a one-way affair.)

Too many questions had to be answered first. Can the higher levels of consciousness (the mental/causal) be contacted with an instrument such as Mark II? In what manner and by what means can the collaborators interact with - and impinge on - our electromagnetic micro-wave carrier, if at all?

It quickly became obvious that our spirit collaborators did not have answers to all of our questions. In fact they reported that they did not have all the answers to how they could manipulate their energies! Thus it became a cooperative effort in which we and they had merely taken the first step with Mark I and Mark II.

6

MARK III and IV

29.570 MHz -- 1977 and Continuing

During recent years Meek has made contacts with many sensitives. In 1975 he met a man who had spent most of his working life in servicing civilian and military electronic equipment. William O'Neil had a small electronic laboratory which, on occasion, was "visited" by "spirit persons." William's high degree of clairvoyance sometimes enabled him to "see" his spirit friends. On rare occasions his clairaudience enabled him to hear comments offered by his visitor and a two-way conversation would result.

One visitor to the lab in 1976, a man whom William could both "see" and "hear", was, like William, interested in electronics. His visitor said he had been in the medical field and one of his hobbies had been amateur radio communication. He became known to William as "Doc Nick." Over a period of many months they cooperated on the development of some rather simple electronic equipment through which they hoped William could actually hear Doc Nick speak. They also worked at modifying a TV set in hope that William could see Doc Nick on TV.

On September 17, 1977 they had their first success with audio communication. The quality of recording on an inexpensive cassette recorder was none too good and conversation itself was full of noises and interruptions. Perhaps only 25% of the words were intelligible. (A portion of this conversation will be found on the cassette which is supplied with this manuscript.) When Meek listened to it, he felt history was repeating itself. He recalled how, more than half a century ago, he had the great thrill of hearing a voice on his home-made radio consisting of a galena crystal, a small wire called a "cat's whisker," a small coil of wire and a set of earphones.

William's small lab had only the most meager of electronic testing equipment and he had been unable to identify and record the frequencies at which the voice contact was obtained. Moreover, personal matters prevented any effective follow-up. When work was resumed, it was no longer possible to contact Doc Nick.

William then acquired more adequate lab equipment -- and just in the nick of time! His next visitor and future collaborator put in his appearance. This man introduced himself as Dr. George Jeffries Mueller, an American physicist. By this time William had learned the need to question his spirit friend in great detail, as per the admonition of the Apostle John to "test the spirits." (Mediumship was common 2000 years ago and some evidence of this still remains in the New Testament despite the extensive effort a few hundred years later to remove such references.)

Dr. Mueller cooperated in a most remarkable manner: he gave his Social Security number, the place where a copy of his death

certificate could be found, complete details of his work at the University of Wisconsin and at Cornell University, exhaustive detail on the various positions he had held in government and industry, etc. Meek checked all such details and located Mueller's former wife with whom various other bits of information could be checked. The correlation was perfect.

[Plans are underway to have a skilled investigative reporter take over the various notebooks of materials collected from 1977 to 1982 and assemble the information into a book. To the best of our knowledge there has never been such a completely documented case of survival. It is hoped that this book will issue in late 1982 or early 1983.]

Dr. Mueller had extensive background in electronics and wrote a small book for the U. S. Army Manual Training Series entitled, INTRODUCTION TO ELECTRONICS. He was most anxious to pick up where Doc Nick had left off on the development of both audio and video equipment.

Basic Concepts

To better understand just what contributions Doc Nick and Dr. Mueller made, let us first consider what is going on in most of the EVP voice recordings. After observing the EVP voice samples on an oscilloscope with the white noise as a carrier, it was apparent that the noise itself was being amplitude-modulated. The resultant sounds were much like a weak whisper, in which air is exhaled rapidly and words are formed by the shape of the mouth cavity. Both amplitude and duration of the EVP words are somewhat limited with this type of communication. Also many people have difficulty understanding whispers without observing lip motions, since the words are lacking in tonal quality.

Doc Nick had suggested using a single tone in place of the white noise used on most of the EVP tapes. Of course his voice showed up on the oscilloscope as amplitude modulation. Efforts were made, with all known techniques, to artificially duplicate this voice, but with no success. While the modulation looked like class A low level modulation, it had no tones or harmonic content from the vocal cords or the mouth cavity.

William's voice was recorded on the same tape as Doc Nick's (September 17, 1977). There was no modulation of the tone, only good mixing. The cassette voice recording of this historic first conversation between Doc Nick and William was sent to the voice analysis laboratory at the University of Florida but efforts there to filter and further analyze Doc Nick's spoken words were non-productive.

When we were in our Florida laboratory (1978) we experimented with an artificial larynx with resulting sounds basically similar to Doc Nick's speech. It was apparent that the mouth cavity and the esophagus (or equivalent) were needed to give good tonal inflection.

Dr. Mueller's Contributions

Dr. Mueller's great contribution was three-fold. First, he used a multi-frequency audio tone instead of incidental, random and uncontrollable white noise. Second, he suggested a specific and complex series of audio tones. The net result is that for the first time, it is possible to achieve tonal inflections of the incoming voice. This was a breakthrough of great significance. (Samples of conversation between William and Dr. Mueller are given on the accompanying tape.)

Dr. Mueller had mentioned that one of his lifelong hobbies had been a study of the theory of music. The knowledge he had gained was put to good use in selecting the mixture of audio tones which make tonal inflections possible. The tonal mixture which makes up the background sound on the accompanying tape is composed of these frequencies in cycles per second: 131, 141, 151, 241, 272, 282, 292, 302, 415, 443, 515, 653 and 701.

His third contribution was the use of an RF signal as the carrier for the multi-frequency audio tone. As of this date, the carrier range frequency is between 29 - 31 MHz, but much research is needed on this point.

Transcripts from one of the cassettes of conversation between Dr. Mueller and William at this stage of the research, show this comment from Dr. Mueller:

The only conditions necessary now for such communication is the desire of the [pause] All right, William, "spirit," if you will, and on your end the constant implementation of the audio frequencies and a volume that is normally available there with you (or whomever is operating the equipment). It remains then that whomever over here wishes to be heard may do so simply by talking, as it were. Of course you can't actually hear them, or even me at this moment, William, but the mechanics of their lip movement and simultaneously thinking (yes, we can and do still think) is automatically conducive to the clarity of the speech -- regardless of whether the initiating pattern be here or there. Do you understand, William?

General Description of the Metascience Mark IV SPIRICOM system

The system as it existed in the mode which made the first breakthrough carrying Doc Nick's voice on September 17, 1977, was called Mark III. While there were basic similarities between it and the one developed with Dr. Mueller's help, the system as we have it today is referred to as Mark IV. As of now it is arranged as shown here:

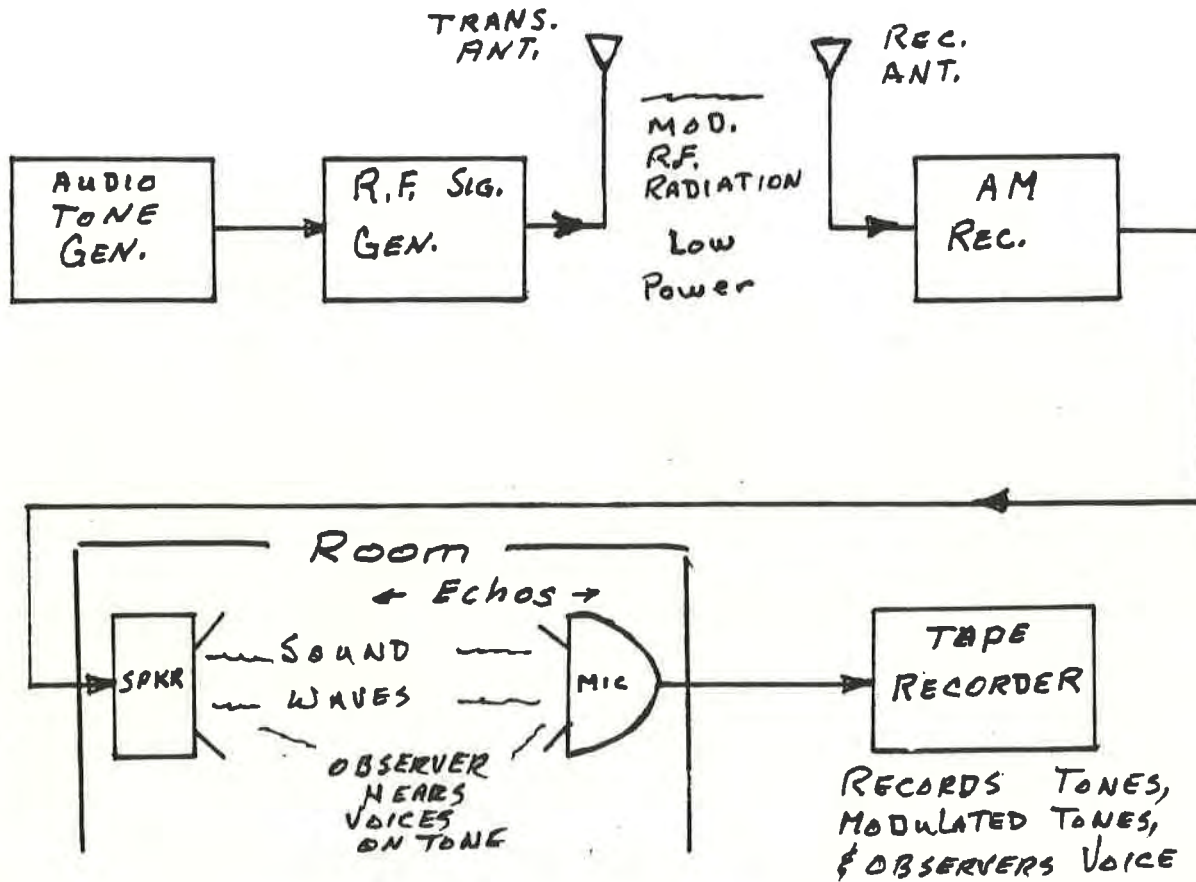

Fig. 11 Functional Block Diagram of Mark IV

This approach provides two space gaps. First is the electromagnetic coupling between the transmit and receiving antennas. The second is the acoustic coupling between the speaker and the microphone. In this set-up, the tones are modulated by the time the microphone and observer hear or pick up the voices. At this time we know that the modulation of the tones takes place somewhere between the audio tone generator and the receiver speaker output. The method and point of modulation are still unknown.

Systems Component Description

The following description will give an understanding as to why some special units are currently used, and mention areas which need further exploration.

1. RF Signal Generator

Metascience Lab is planning use of an hp 608 RF Signal Generator covering a frequency range of 10 to 421 MHz. It is limited to amplitude modulation only. Other RF Signal Generators with suitable stability, modulation and an appropriate frequency range could be used. Also a variable output should be available.

2. Transmitter Antenna

While the antenna is approximately a $1/4$ wavelength at the particular frequency used, it was intentionally made non-resonant

so frequency shifts could be made without worry as to antenna characteristics. The antenna consists of a piece of coax ten to twelve feet long with about an eight-foot bare wire attached to the center conductor. This piece of wire is then secured to a wooden (non-metallic) stand to hold it upright. This length is used for the HF band. Other frequencies and bands may require different lengths of wire for the antenna radiator.

3. AM Receiver

Presently the above antennas are used only in the HF band. Metascience is planning to use a Hammarland SuperPro 600 HF multi-band receiver. Other frequencies in the VHF and UHF bands have been used but with limited success.

4. Receiving Antenna

This antenna is identical to the transmitter antenna. After both are attached to the RF Signal Generator and the receiver, the distance between them should be 4 to 6 feet ($1\frac{1}{2}$ to 2 meters).

5. Speaker

Since the Hammarland Radio does not have an internal speaker, a standard 5" permanent magnet speaker with the necessary matching transformer was attached to the receiver.

6. Microphone and Tape Recorder

The microphone is a conventional electret type for increased sensitivity. The tape recorder is a reel type which provides a gain control while recording. (Most cassette recorders have an AGC system built in and this tends to reduce the sensitivity because of the tone.)

7. Audio Tone Generator

A single cassette tape is prepared by a process using two tape recorders. After the first tone is recorded, that tape is played back simultaneously with the audible generation of the next tone and recorded on the second cassette recorder. This procedure is repeated until all of the tones are recorded on the one cassette. This system has obvious disadvantages, including the build-up of noise.

Because of the crucial role of this mixture of tones, it was decided that the necessary time and money would be spent to design and build a more sophisticated piece of equipment. The prerecorded tape does not allow for research into the relative amplitude of the various tones and has the disadvantage of multiplying the wow and flutter in most small cassette tape recorders.

The new Metascience Multitone Generator will provide individual crystal-controlled frequencies, individual selection and amplitude control for tonal balance. Frequencies will be extremely accurate, stable and repeatable. It should be available for its initial testing shortly.

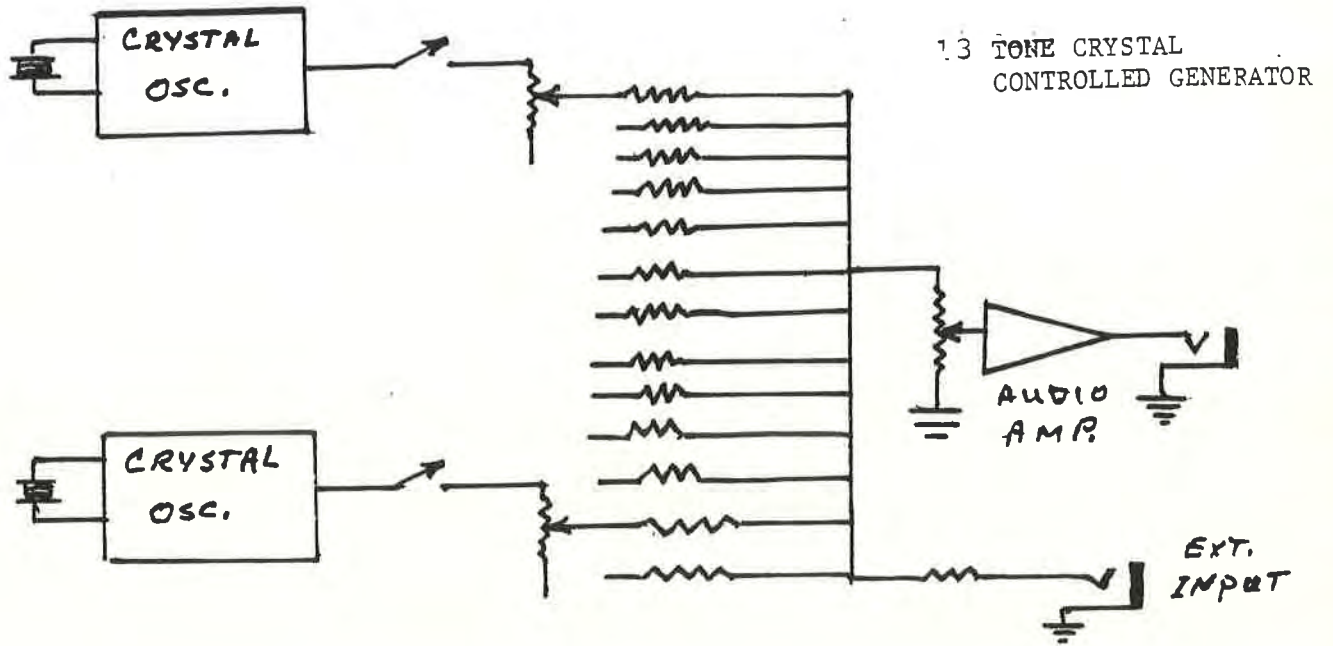

Fig. 12

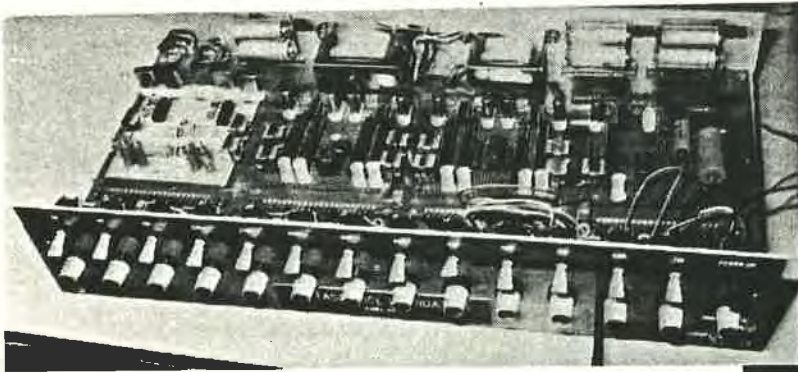

Fig. 13 Metascience
Multitone generator

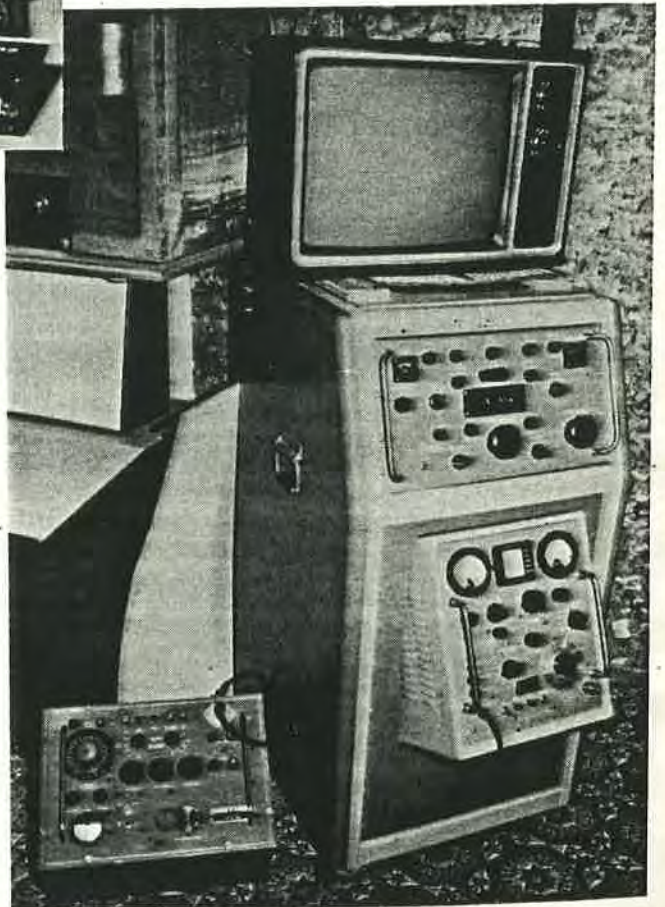

Fig. 14 RF Signal Generator and
Receiver

Theoretical Speculations

We frankly admit that we have made only a small start at devising a theoretical basis for understanding Dr. Mueller's great contribution of identifying 13 specific tones which help to create a reasonably life-like reproduction of his voice.

In our literature research we have found several items that seem to give insight. Langston Day in the following quotation from *MATTER IN THE MAKING* (London: Vincent Stewart, Ltd., 1966) seems to be speaking directly on the situation with which we are involved in Mark IV.

Two kinds of Music

Resonance between corresponding notes and chords in different octaves, or in similar octaves of different kinds of radiation, links the Universe together on all levels. What does this mean?

The Universe consists of various kinds of energies and matter. Each energy can be regarded as a vibration or a pattern of vibrations, whether it is heat, light, electricity, thought, sound, or whatever. Furthermore, both sound waves, which are vibrations in air, and the vibrations of the electromagnetic spectrum, which take place in a so-called ether, are arranged in a series of octaves.

If we produce a note, or a wave-form of sound, it can resonate with components of a corresponding note or wave-form in, say, a radio-wave band or in some higher octave such as that of light. Various experiments have shown this. For instance, Professor Tyndall discovered that flames would respond to sounds, especially to those of higher pitch. Various energies from the Sun interact in the biological sphere and promote growth.

Since we live in an atmosphere which acts as a medium for sound waves it is only to be expected that we should be able to use sonic vibrations of some kind to resonate with higher octaves and so connect us with higher levels of existence. This, no doubt, is why music according to legend was given to man by the gods. The inner meaning of music was once an important part of all the great religions and a practical guide to the art of government and the ordering of society.

'Music,' says Confucius in the *Li-ki*, 'being intimately connected with the essential relations of beings and the vital spirits of men tuned to the tone of heaven and earth, they thus express all the frequencies of heaven and earth, as several cithars all tuned to one tonic, Kung, equally vibrate together when the note Kung is sounded.' At one time the Chinese based good government and morals on observance of the harmonic rules laid down in their musical canon.

In ancient Egypt Hathor, Goddess of the Supersonic Heights, was represented wearing a head-dress resembling a tuning-fork. India's Parvati, wife of Shiva, is said to have symbolised the etheric vibrations evoked in Shiva, the God-head, by the ordered frequencies of trained harmonic thought-power. This is particularly remarkable in view of de la Warr's discoveries.

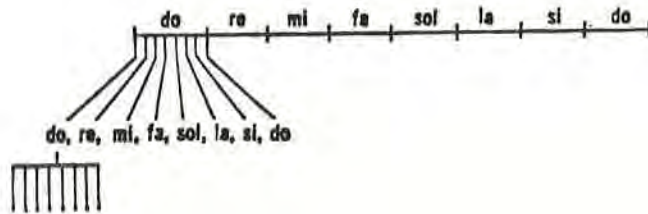

Diagrammatic representation of the expression 'the inner octaves' used by Gurdjieff. (From *In Search of the Miraculous* by P. D. Ouspensky, published by Routledge and Kegan Paul).

The Druids of Britain had a profound knowledge of harmonics, much of which was contained in their great library at Bangor until it was burned by the Christians. Even today there is some glimmering of understanding among scientists that physics and religion are connected by the laws of harmony. In a B.B.C. broadcast Professor E. N. C. Andrade said, 'The electron that answers to harmonic frequencies as do crystals and our nervous system also, leads us to the doorway of religion.'

The music which we know today is not at all what it was originally, for it no longer depends upon inner octaves. Instead of octaves within octaves, music is much coarser in spite of its elaboration, for it has lost its finer shades of tone and much of its objective power.

Speaking of these inner octaves, G. I. Gurdjieff, as reported by P. D. Ouspensky, said: 'Each note of any octave can be regarded as an octave on another plane. Each note of these inner octaves again contains a whole octave, and so on for some considerable way but not *ad infinitum* because there is a definite limit to the development of inner octaves.'

He went on: 'These inner vibrations proceed simultaneously in "media" of different density, interpenetrating one another; they are reflected in one another, give rise to one another; stop, impel, or change one another.'

These media are sometimes called 'The ether', but there is probably a series of ethers. *

Gurdjieff then spoke of different levels of existence and explained that a single note of a vibration on one level contained in itself a whole octave of vibrations on the next level above. It will be seen that in passing to an inner octave we are dealing with finer, more active forms of energy. In other words 'inner' is the same as 'higher' and we are ascending in the fifth dimension. And each level is associated with a finer form of ether.

* See Appendix A

Further valuable insight is given by Dr. Walter Russell in THE UNIVERSAL ONE. This book is not readily available in the libraries of the world and new copies cost \$100 each. For the information of serious researchers we therefore reproduce a portion of the pertinent chapter.

Upon first reading, the material is very difficult to comprehend. (The information presented was obtained during a phenomenal "cosmic consciousness" experience that lasted for 39 days -- perhaps the longest on which we have detailed records.) This portion contains terms, the meaning of which had been developed in earlier chapters. We have indicated certain paragraphs which seem to be particularly related to what is involved in the octaves of sound which are represented by Dr. Mueller's 13 tones and their many harmonics.

CHAPTER XXVII

EXPRESSIONS OF GRAVITATION AND RADIATION

TONE—THE SEVENTEENTH DIMENSION

Tone, in the sense in which we understand the meaning of the word sound, is one of the great dimensions.

Tone is registered in sound as it is in color, plane, temperature and other dimensions.

Every expression of energy has its own particular tonal sound just as it has its own color plane or degree of temperature.

Sound is generally conceived to be the result of a concussion taking place in the air. The "ether of space" is generally conceived to be soundless. This concept is not in accord with the laws of motion.

Sound is from the beginning and from the very first octave.

It matters not how low or how high the potential, every active and reactive oscillation is accompanied by sound.

Sound increases in resonance as potential accumulates. Both effects of motion are due to the same cause, the generation of accumulated energy from the first to the tenth octaves and its radiation into inertia.

All states of motion register themselves tonally in the opposites of sound in the same periodicity as they register themselves in the other dimensions.

All sound is caused by potential impacting against potential or separating from potential.

All sound is the result of explosions of accumulating or redistributing energy.

Every generative action and every radiative reaction is an explosion.

All explosions are either genero-active or radio-active.

Genero-active explosions are those in which two opposing potentials seek each other with violence. Such explosions are gravitative. They are born of centripetal force and they are due to the power of matter to appear to attract.

Genero-active explosions draw corpuscles into forming mass. These are the explosions by means of which mass is accumulated.

Genero-active explosions are endothermic or heat absorbing.

Radio-active explosions are those in which high potential discharges into lower potential with violence. Such explosions are radiative. They are born of centrifugal force and they are due to the power of matter to appear to repel.

Radio-active explosions eject corpuscular emanations from mass. These are the explosions of expanding mass by means of which accumulated mass is redistributed.

Radio-active explosions are exothermic or heat expelling.

Genero-active explosions are caused by the desire of positive charge to accumulate as mass.

THE UNIVERSAL ONE

Radio-active explosions are caused by the desire of negative discharge to redistribute accumulated masses of stored energy into a state of inertia.

Genero-active and radio-active explosions in sequence are analogous to the intake and exhaust of a pump.

The preponderance of one or the other is the condition precedent to mass formation or mass dissolution.

The alternating explosive oscillations which simultaneously integrate and disintegrate evolving and devolving mass cause sounds of greater or less intensity according to the potential position of the actions and reactions which cause those sounds.

Just as all motion is expressed in waves so are all waves registered in their various dimensions.

All states of motion are measurable as dimensions.

Sound is a dimension.

Sound being a dimension is, therefore, measurable.

Explosions in the low potential position of the first six octaves are registered in the elements as full tones. Each full tone of sound is a whirlpool formed around a central nucleus, or vortex, toward which the generative energy induced by the effect of the explosion rushes with increasing violence, and away from which the reaction to that explosion rushes with decreasing violence.

When energy accumulates to the high potential positions of the sixth and seventh octaves, the tonal explosions take place as full tones from the $\text{O} =$ position in inertia to the $3+$ and $3-$ positions in their octave waves.

At these points the accumulation of genero-active and radio-active force is so great that five mid-tonal vortices are formed between those positions and the over-tone of the wave. These mid-tonal vortices are the bases for ten new elements to each octave, five of which are positive and the other five negative.

In the still higher potential positions of the

eighth, ninth, and tenth octaves many more mid-tonal vortices appear which form the bases of many more elements, half of which in each octave are positive and half negative.

Sound emanates from the explosions of every potential no matter how low or how high. More than this, the sound from either genero-active or radio-active explosions, register themselves in every octave both higher and lower than the octave of source.

For a familiar example let us consider the sound of the human voice which is a genero-active explosion because of the fact that it is a higher potential generated out of a lower.

The series of explosions which give birth to this sound becomes radio-active in the lower octaves and redistributes that accumulated energy into the lower potentials against which it impacts in that state of potential which we would term the air. The sound radiates slowly but its discharge into the potential of the lower octaves will travel around the planet several times while the same sound travels across the valley through the air.

On the contrary, its impact against a cliff will retard its progress in the higher potentials of higher octaves but the sound continues to the end of the cycle. The cliff side undergoes an increase in positive charge because of the impact of energy against it.

Just as we can hear the explosions of genero-active energy through the senses of hearing by impact of that energy against our ear drums, so can the explosions of low potential be reproduced with delicate instruments so that their regeneration into higher octaves would make them discernible to our sense of hearing.

The bombardment of radio-active emanations can even now be amplified so that they can be heard. Master mechanics must devise instruments so delicate that low potential explosions may be amplified and measured with as great accuracy as they have devised instruments for recording even a millionth degree of temperature.

It must be remembered that all explosions travel both ways, up and down the octaves,

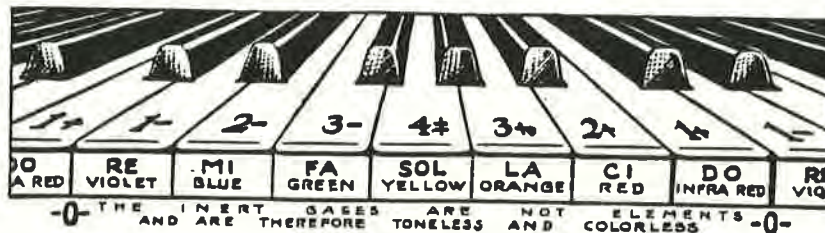

for there can be no action without a corresponding reaction nor can there be a reaction of an action without a repetition of both.

This is a universe of reproduction and any effect of motion runs the entire gamut of all effects of motion. The force of that which is running away from inertia is equal to the speed of that which is returning to inertia. The speed of one is very great and its force very little. On the contrary the force of the other is very great and its speed very little.

For the purposes of comparing the variable relation of tone to the attraction of gravitation and the repulsion of radiation it is only necessary to point out the different speeds at which any sound reproduces itself according to the potential in which the sound finds itself.

Just as high potential discharges into low with ever increasing speed of reproduction, so does sound raise its tone and increase its reproductive speed. It also decreases its wave dimensions as potential powers.

Just as nature's mechanical principles do not permit a waste of energy by allowing the discharge of any accumulated energy to be used without repeated regeneration, so must that gradual and sequential discharge and recharge be registered in ever lessening sound intensity and with ever increasing speed as power diminishes.

In any mass the lower the octave the higher the potential and the slower the speed of reproduction of any effect of motion.

In any mass the higher the octave the lower the potential and the greater the speed of reproduction of any effect of motion.

In any mass the lower the octave the greater the wave dimension and the lower its tonal registration in sound.

In any mass the higher the octave the smaller the wave dimension and the higher its tonal registration in sound.

Low potential radio-active explosions can be amplified and regenerated to genero-active ones of electro-positive force.

When measurements of tonal positions are made possible and correlated to plane, color, temperature and other dimensions, a higher and more complex chemical analysis than that of to-day will be made possible.

The simple, modern chemical analysis of a grain of wheat will not allow a synthesis which will enable one to produce the same substance. The more complex chemical analysis of all of the dimensions which enter into that grain of wheat will make it possible to reproduce exactly that substance even to the retaining all of its attributes.

If the premises above stated are sound and the facts are true, it must necessarily follow that the states of motion which produce genero-active and radio-active explosions must in some manner be related to the power of matter to appear to attract and repel.

If varying potentials have varying power to appear to attract or repel, the force which we call repulsion must necessarily be a variable and relative force. The variability and relativity of this force must be dependable upon the relative potential position of that force.

If these premises are well founded then the seventeenth dimension must be taken into consideration in the writing of the laws of gravitation and radiation.

It must necessarily follow that the attributes of attraction and repulsion which seem to belong to matter are merely illusions in respect to matter for they belong to motion only.

Finally, and again as a service to serious researchers we share some not readily available data regarding the frequencies of tones in their octave relationship. For convenience, we repeat the tabulation of the tones specified by Dr. Mueller:--

131--141--151--241--272--282--292--302--415--443--515--
653--701 C.P.S.

BEATS PER SECOND IN EQUAL TEMPERED INTERVALS (ASCENDING) FROM C^o TO C⁸ INCLUSIVE, CORRECT TO 2 PLACES OF DECIMALS.

Name	C. P. S.	Minor Third	Major Third	Fourth	Fifth	Minor Sixth	Major Sixth	Frequency Ratios Ascending
		5:6	4:5	3:4	2:3	5:8	3:5	
		6th & 5th	5th & 4th	4th & 3rd	3rd & 2nd	8th & 5th	5th & 3rd	
		Narrowed by	Widened by	Widened by	Narrowed by	Narrowed by	Widened by	Widened or Narrowed
C ^o	130.813	7.06	5.19	0.59	0.43	8.26	5.93	
C ¹ -D ^{b1}	138.591	7.47	5.50	0.62	0.46	8.73	6.29	
D ¹	146.832	7.92	5.82	0.66	0.49	9.25	6.76	
D ¹ -E ^{b1}	155.563	8.39	6.07	0.70	0.52	9.79	7.06	
E ¹	164.814	8.89	6.53	0.74	0.55	10.38	7.47	
F ¹	174.614	9.42	6.93	0.79	0.59	10.99	7.92	
F ¹ -G ^{b1}	184.997	9.98	7.34	0.83	0.62	11.64	8.39	
G ¹	195.998	10.57	7.77	0.88	0.66	12.34	8.89	
G ¹ -A ^{b1}	207.652	11.20	8.26	0.94	0.70	13.08	9.42	
A ¹	220.000	11.87	8.73	0.99	0.74	13.86	9.98	
A ¹ -B ^{b1}	233.082	12.57	9.25	1.05	0.79	14.68	10.57	
B ¹	246.942	13.32	9.79	1.11	0.83	15.56	11.20	
C ²	261.626	14.12	10.38	1.18	0.88	16.48	11.87	
C ² -D ^{b2}	277.183	14.95	10.99	1.25	0.94	17.46	12.57	
D ²	293.665	15.85	11.64	1.32	0.99	18.50	13.32	
D ² -E ^{b2}	311.127	16.79	12.34	1.40	1.05	19.60	14.12	
E ²	329.628	17.79	13.08	1.47	1.11	20.76		
F ²	349.228	18.84	13.86	1.58	1.18			
F ² -G ^{b2}	369.994	19.96	14.68	1.67				
G ²	391.995	21.15	15.56	1.77				
G ² -A ^{b2}	415.305	22.41	16.48					
A ²	440.000	23.74						
A ² -B ^{b2}	466.164							
B ²	493.883							
C ³	523.251							

FREQUENCIES (C. P. S.) OF ALL TONES OF THE PIANO BASED ON THE AMERICAN STANDARD PITCH (A. S. A. standard, 1936), A₄₄₀=440 C. P. S. ACCORDING TO THE SYSTEM OF EQUAL TEMPERAMENT AND CORRECT TO THREE PLACES OF DECIMALS.
 Note-1: This table has been compared with the table of frequencies that forms part of the Standards for Acoustical Terminology (Z24.1-1936), published by the American Standards Association.

Name	C ¹ Octave		C ² Octave		C ³ Octave		C ⁴ Octave		C ⁵ Octave		C ⁶ Octave		C ⁷ Octave	
	No.	C. P. S.	No.	C. P. S.	No.	C. P. S.	No.	C. P. S.	No.	C. P. S.	No.	C. P. S.	No.	C. P. S.
A	1	27.500	13	55.000	25	110.000	37	220.000	49	440.000	61	880.000	73	1760.000
A ¹ -B ^{b1}	2	29.135	14	58.270	26	116.541	38	233.082	50	466.164	62	932.328	74	1864.655
B	3	30.868	15	61.735	27	123.471	39	246.942	51	493.883	63	987.767	75	1975.533
C	4	32.703	16	65.406	28	130.813	40	261.626	52	523.251	64	1046.502	76	2093.005
C ¹ -D ^{b1}	5	34.648	17	69.296	29	138.591	41	277.183	53	554.365	65	1108.731	77	2217.461
D	6	36.708	18	73.416	30	146.832	42	293.665	54	587.330	66	1174.659	78	2349.318
D ¹ -E ^{b1}	7	38.891	19	77.782	31	155.563	43	311.127	55	622.254	67	1244.508	79	2489.016
E	8	41.203	20	82.407	32	164.814	44	329.628	56	659.255	68	1318.510	80	2637.021
F	9	43.654	21	87.307	33	174.614	45	349.228	57	698.456	69	1396.913	81	2793.826
F ¹ -G ^{b1}	10	46.249	22	92.499	34	184.997	46	369.994	58	739.989	70	1479.978	82	2959.955
G	11	48.999	23	97.999	35	195.998	47	391.995	59	783.991	71	1567.982	83	3135.964
G ¹ -A ^{b1}	12	51.913	24	103.826	36	207.652	48	415.305	60	830.609	72	1661.219	84	3322.438

Conclusions:

In this brief initial report on Mark IV SPIRICOM research, we state that we have had good quality communication with only four different spirit persons, that we have had successful communication in only one location and with only one researcher. Moreover, the communication is sometimes interrupted for days or even weeks at a time. An explanation for this interruption may be that communicators can, with the passage of time, progress upward in the area shown on the "Many Mansions" chart, and in so doing get beyond the range of reception of Mark IV.

(This sporadic contact problem has been common with all EVP research in the past 20 years. Raymond Cass of England is reported to have had a period of two years of complete inactivity before he was again in contact.)

All of the many disrupting and limiting factors you will learn about in Chapter 9 of this book and from the messages given by the direct voice communicators on the cassette, add to our frustration at this early stage of SPIRICOM research.

Nevertheless we feel it is a tremendous achievement indeed to have had many hours of sustained high quality two-way conversation, over many months, and that the content of the communication was informative. We can confidently continue our research on isolating and identifying those factors which must be overcome to make Mark IV of practical value to many researchers.

In Chapter 10 you will be exposed to some exciting ideas for research aimed at identifying and then eliminating these many unknown variables.

And while we are naturally not satisfied to rest on our laurels, we can take heart in the fact that we have succeeded where Marconi, Edison and Tesla (lacking solid state electronic equipment) failed in achieving sustained conversation with persons who have been in the worlds of Spirit for many years.

Present Status (February 1982)

As of the time this first edition of SPIRICOM goes to press, we state:

1. We do not know what part, if any, the successful operation of Mark IV in its present embryonic form, depends on the operator possessing some form of psychic energy.
2. We are of the opinion that our Mark IV SPIRICOM system, in its present embryonic form, probably cannot be used for conversing with persons residing at any level above the border zone where the lower and middle astral planes merge-- as depicted in the large diagram, IN MY FATHER'S HOUSE THERE ARE MANY MANSIONS.
3. We have reason to believe that those spirit persons whose voices are recorded in the SPIRICOM portion of the cassette tape, "SPIRICOM -- Its Development and Potential" have now evolved to levels where they are beyond the range of frequencies which can be "tuned to" with this system.
4. Our limited success to date emphasizes the desirability of other researchers joining in to help solve the problems.

UPDATE # 1 to the SPIRICOM Technical Manual - - -July 30, 1982

(These pages are supplied as a supplement to follow page 41.)

When the manual was first issued in February 1982, we very clearly stated that Metascience Foundation had very little interest in carrying the Mark IV system development much further. We stated that it was limited to communication with the lower astral. We clearly stated (inside the front cover) that, to the best of our knowledge, the Mark IV system had no possibility of operation without the input of a very special type of unidentified energy from a psychic person, and that among our six electronic technicians, only one, William J. O'Neil, had such energies. We cautioned that, while it was true that we had been fortunate to have had extensive contacts with a brilliant man such as Dr. Mueller (before he departed the lower astral) we felt that it was unwise for a newcomer to this research to spend time and money to build Mark IV equipment.

Because we suspected that many persons newly introduced to SPIRICOM would disregard these friendly suggestions, we presented in Chapter 10 suggested guidelines for further research. However, letters and telephone calls have shown that most experimentors are determined to spend their time and money on Mark IV.

We ourselves followed the course of action outlined in Chapter 10. We have now organized projects on Mark VI (flame transducer), VII (electrically activated quartz transducer) and VIII (living plant as a transducer). We are far enough into these projects to see that all three represent formidable undertakings and will require from one to several years to explore each project.

Obviously, if a person purchases a SPIRICOM Manual, he or she is a free agent to use any part of the information. If he or she chooses to try to make a quickie contact with the lower astral, has the time and money to build Mark IV, and has a suitable psychic energy source, it is up to him or her to make the decision. Our aim is to help all serious researchers. It is in keeping with that aim that we have prepared this supplement.

The specific function of UPDATE #1 is to provide additional information on Mark IV -- information beyond the simple block diagram in Fig. 11, page 32. On page 41 we stated that the system was in an embryonic form. We made no attempt to report on several related experiments with Mark IV which we had just started, not only because they were in the process of being explored, but also because, quite frankly, we did not fully comprehend their ramifications.

About the mid-point of the Mueller-O'Neil collaboration, Mueller began to introduce subtle equipment modifications which may someday have use far beyond the Mark IV project. However, O'Neil, often working until dawn (because contacts seemed best during the early morning hours) did not keep accurate written records of either equipment modification or individual experiments.

The full import of these two factors came to the attention of Meek in February just as he was departing on a trip around the world. There was neither time nor personnel for an up-date to the Mark IV material already printed and bound as pages 29-41.

Bruce Dapkey was assigned the task of spending the needed time to visit O'Neil and document as precisely as possible just what the operational situation was during the closing days of the Mueller contacts in late 1981. Dapkey found that the system had become far more sophisticated than was represented in Fig. 11. Here is a condensation of his report:

MARK IV UPDATE REPORT

By Bruce Dapkey

1. INTRODUCTION TO UPDATE

The Mark IV system evolved from initial experiments with single side band radio and at the time Fig. 11 was prepared, the system consisted of an RF transmitter and receiver using AM modulation. A mixture of 13 tones was used to modulate the AM carrier.

The equipment used was an RF transmitter, an RF receiver, amplifier and speaker, two tape recorders and the 13 tone mixture.

Since O'Neil did not have equipment capable of producing the 13 tone mixture using an n-channel mixer, he was forced to resort to the laborious course of generating one tone at a time.

2. MANUFACTURING THE TONE TAPE

The first tone was fed into the RF-transmitter (xmt), directly picked up by the RF-receiver (rcv) and then this demodulated tone was amplified and acoustically aired. The microphone picked up this resultant tone that fed the first tape recorder and the first tone copy was made. Each successive tone was added by modulating the RF-xmt with the next tone, feeding that output into the RF-rcv, amplifying and audibly reproducing this tone through the RF-rcv's speaker. The new tone through the RF-rcv's speaker and the previous recorded tone played back through the tape recorder's speaker (or external amplifier and speaker) were recorded on the second tape recorder using the microphone to mix the tones.

Now this "daisy chain" technique continued by taking the tape just made (RF-rcv speaker's playback and first recorder's tonal playback recorded) and playing it back through the first tape recorder's speaker while adding the next tone by feeding it into the external modulation input of the RF-xmt linked to the RF-rcv and its speaker.

The next copy materialized by audibly mixing the resultants through the microphone into the second tape recorder. This tandem process was slow and introduced a considerable amount of RF-xmt/RF-rcv noise not to mention the speaker-microphone noise and last but not least the tape recorder noise. Interestingly enough, ALL communications were made using tone tapes produced in this manner.

The preceding discussion on just how to produce tone tapes might give the reader some more ideas as to what other ingredients could be added to an adjustable 13 tone generator.

3. THE TWO SUBSYSTEMS OF MARK IV.

The ingredients that make up the SPIRICOM system will be briefly reviewed in order to gain some perspective on the updated

Mark IV system. The Mark IV system can be divided into two basic subsystems: an electro-acoustic system and a human supersensitized energy bridge system. Both of these subsystems (if you will) evolved to a more sensitive or finer degree during the months of contact between Mueller and O'Neil. The Mueller-O'Neil bridge went from a heavy (or coarse) clairvoyant and clairaudient experience to a finer more subtle interaction. In other words Mueller was disappearing from O'Neil and the thread that connected them was becoming thinner and thinner. It is not far-fetched to conclude that Mueller had a great deal of awareness with his own consciousness and his own progress. In October, 1981, he told O'Neil that he would not be around forever. Mueller was a technical strategist and in light of his coming vibrational changes, began to introduce a more sensitive electro-acoustic subsystem. We will call this system the frequency modulated transceiver feedback device or FM-TFD subsystem.

4. A NEW ELECTRO-ACOUSTIC SUBSYSTEM - FM-TFD

Under the guidance of Mueller, O'Neil built the first version of the FM-TFD subsystem, or you might say the first ingredient. Referring to Fig. 11A you will see the plan view of a room with a hoop antenna across from a standard FM receiver. The antenna is hanging from the ceiling with the bottom of the loop approximately at chest height. The hoop is a circular velocity-corrected-folded-dipole antenna. (Construction techniques are given in Fig. 11B.)

This type of electronic operation is not a breakthrough in function but presents a dynamic way of experiencing energies that are normally "invisible" to human experience at this time. I'm sure most of the readers are aware that these "invisible energies" are an every day experience to psychics. What makes this system dynamic becomes very evident when a psychic operates and controls the energy field produced by the FM-TFD system functioning in mode # 1.

5. FM-TFD IN MODE # 1

Fig. 11C is a block schematic and layout of the FM-TFD system in mode #1. The transceiver feedback device drives the hoop antenna with its carrier frequency. The microphone that is built into the FM-TFD acts as the receiver and the high frequency oscillator acts as the transmitter. The acoustic pickup frequency modulates the carrier. A similar device on the electronic market is the Radio Shack "Mr. Microhone" or an inexpensive FM walkie-talkie. Facing the hoop/FM-TFD unit is a standard FM receiver with amplifier and speakers (i.e. an FM stereo system).

The FM-TFD system is "balanced" (following a system power-up and being very calm and still) by gradually increasing the volume control for the FM stereo system till acoustic avalanche is reached. Then the volume control is reversed very slowly until the acoustic feedback just shuts off. The FM-TFD is now in mode #1, Fig. 11C.

We have found that human energy fields, astral and/or spirit energy fields affect the "balance" of the system. A disturbance can be easily noted when the system goes out of balance by the resulting

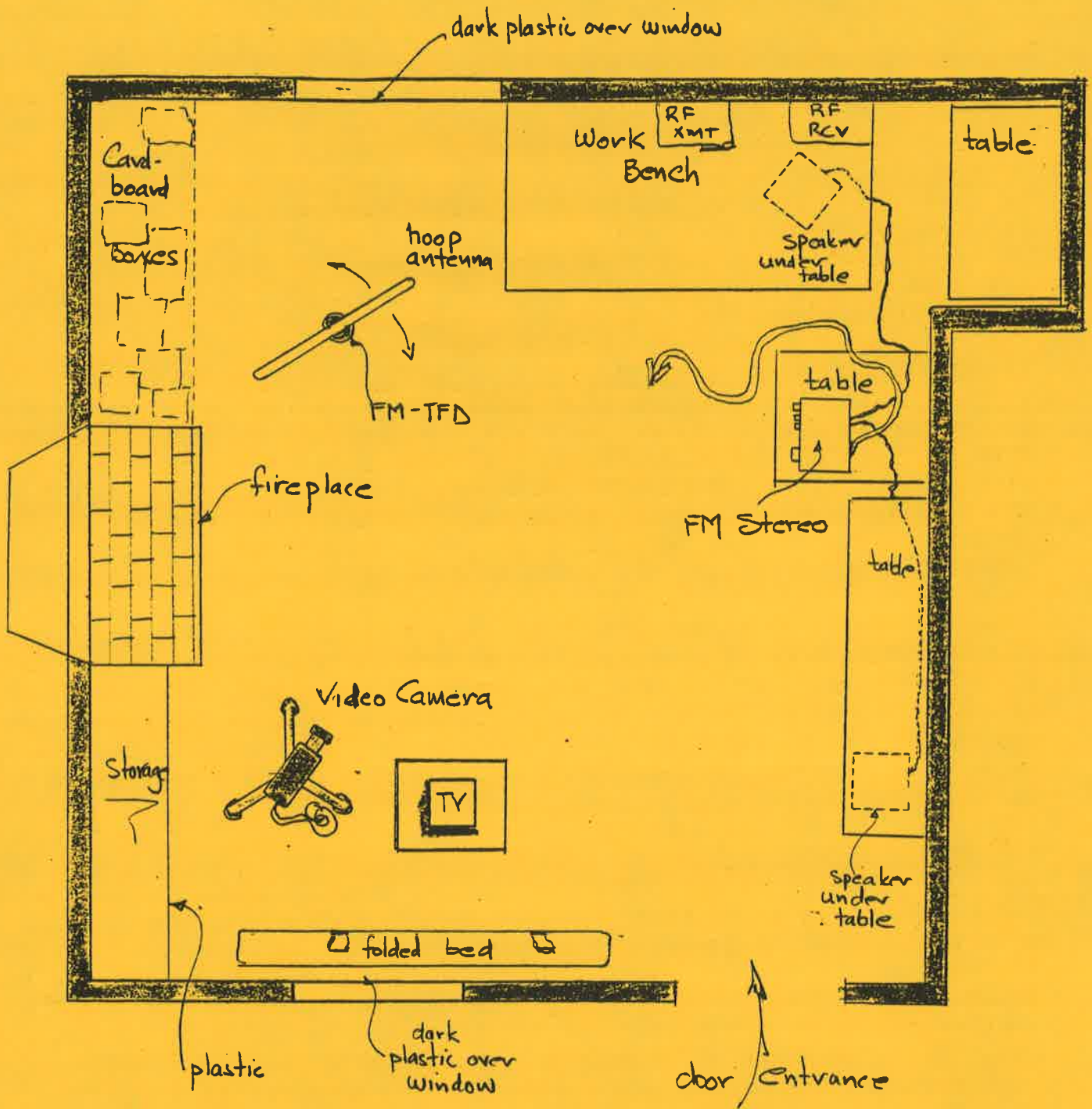

O'Neil Lab

Figure 11A

CONSTRUCTION TECHNIQUES
FOR -FM-TFD- & -HOOP ANTENNA-

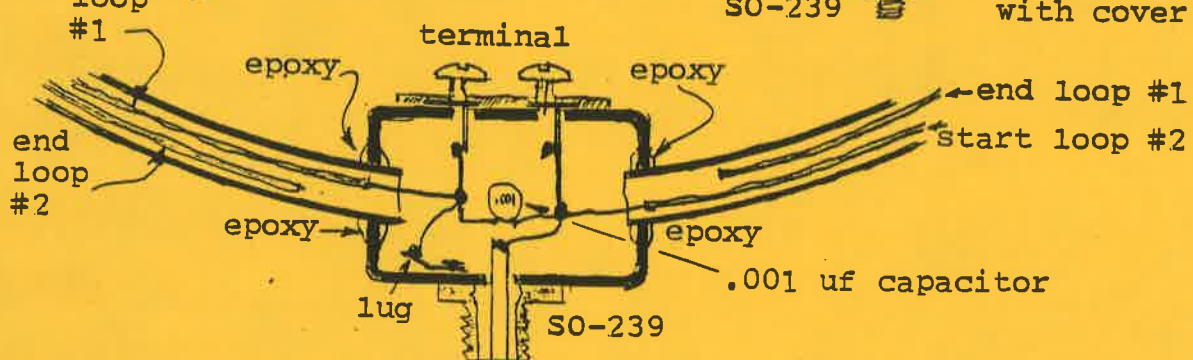
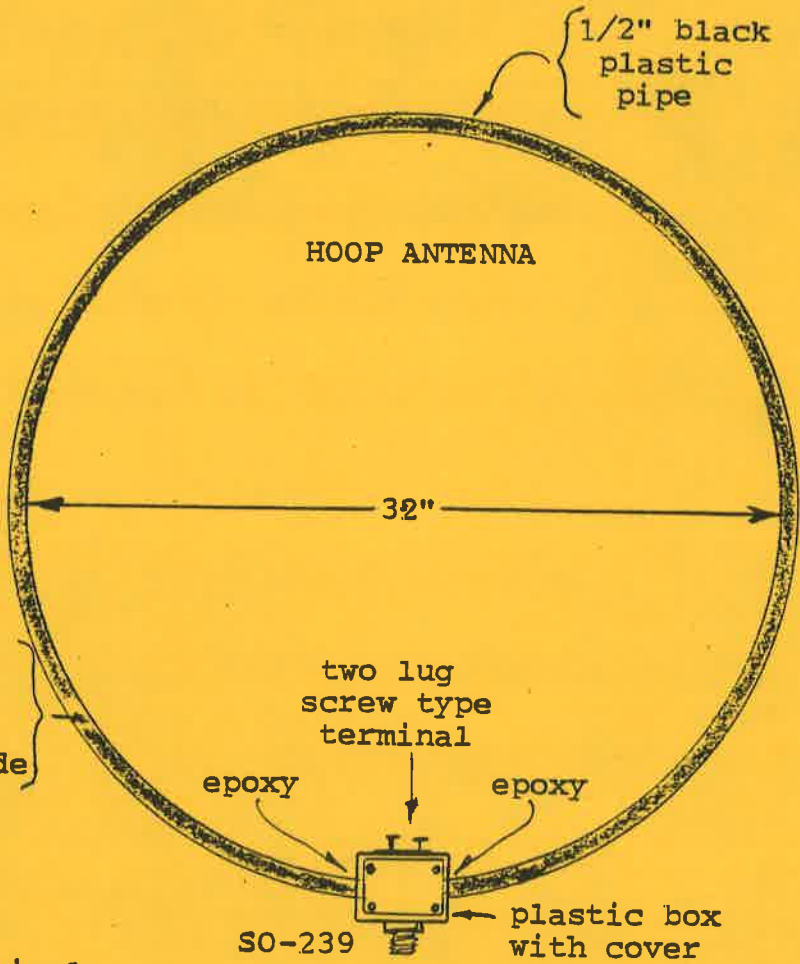
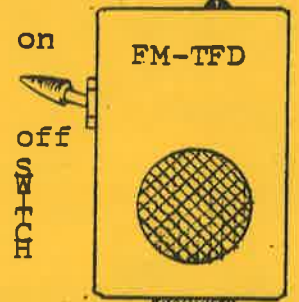
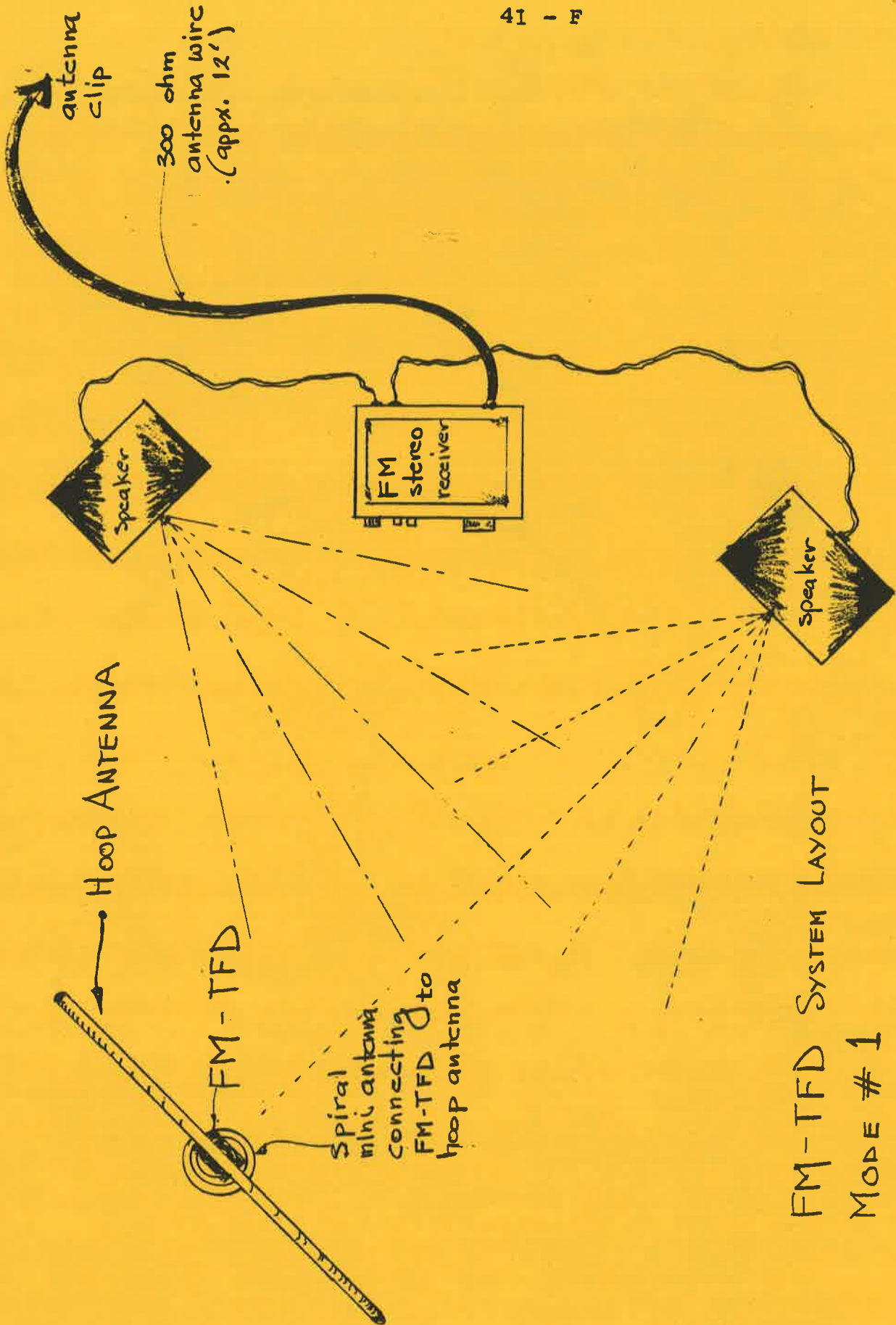

Figure 11B



FM-TFD SYSTEM LAYOUT
MODE # 1

Figure 11C

creation of some form of dominant acoustic tone.

O'Neil's first experiences were instructional. He spoke of this system as a "spirit presence detector". He was able to tune in radio stations that were NOT broadcasting at the carrier frequency of the FM-TFD unit. O'Neil was also capable of standing absolutely still and using his "broadcasting" to affect the "balance" of the FM-TFD system.

The system seems capable of feeding back changes in emotional states. Several other persons that we have experimented with can also affect the "balance" turning the tone generating aspect on and off at will. They may also provide a conducive environment for outside influences. Following this first success, the system (FM-TFD) was ready for its next mode of operation, which we call mode #2, Fig. 11D.

6. FM-TFD IN MODE #2

With the addition of a tape recorder to the FM-TFD unit the Mark IV system had a new electro-acoustic subsystem complemented by the evolved supersensitized energy bridge subsystem. The "Mueller-O'Neil bridge" was thinning out but successful FM communications were made near the very end of the Mueller contact. Mueller's disappearance put an end to the Mueller-O'Neil voice communication.

Now let us take a close look at -

6.1 THE TWO KEY CONCEPTS

Fig. 11D shows the layout of the Mark IV updated system in the O'Neil laboratory. Referring to Fig. 11E, you can see that a simplistic mapping of the "energies" has been overlaid to give some idea as to the nature of its operation. There are two key concepts involved, feedback and harmonic formation. Under the concept of feedback we have the overt and the covert phenomena. Overt feedback can be broken into two more divisions, the electromagnetic feedback and the acoustic feedback.

6.2.1 OVERT FEEDBACK

The electromagnetic feedback occurs between the FM-TFD transmitted carrier of approximately 91Mhz and the FM receiver tuned to the same frequency. It should be noted that the frequency selected is chosen by finding a "quiet" point on the FM band which is usually between two broadcasted stations. In the O'Neil area 91.6 Mhz turned out to be a good quiet point. It should also be noted that the same balancing technique is used as was previously discussed for mode #1. Balancing is achieved for mode #2 when a detuned avalanche is reached. The other overt feedback is the acoustic feedback.

Referring again to Fig. 11E, you will note the tape recorder and its transduced audible output. The generated sound is the 13 tone composite manufactured by the Mueller-O'Neil technique. (See the previous reference on the tone tape.) The audible tone mixture is

tone harmonics via reflections - sound packet gens - harmonic formation

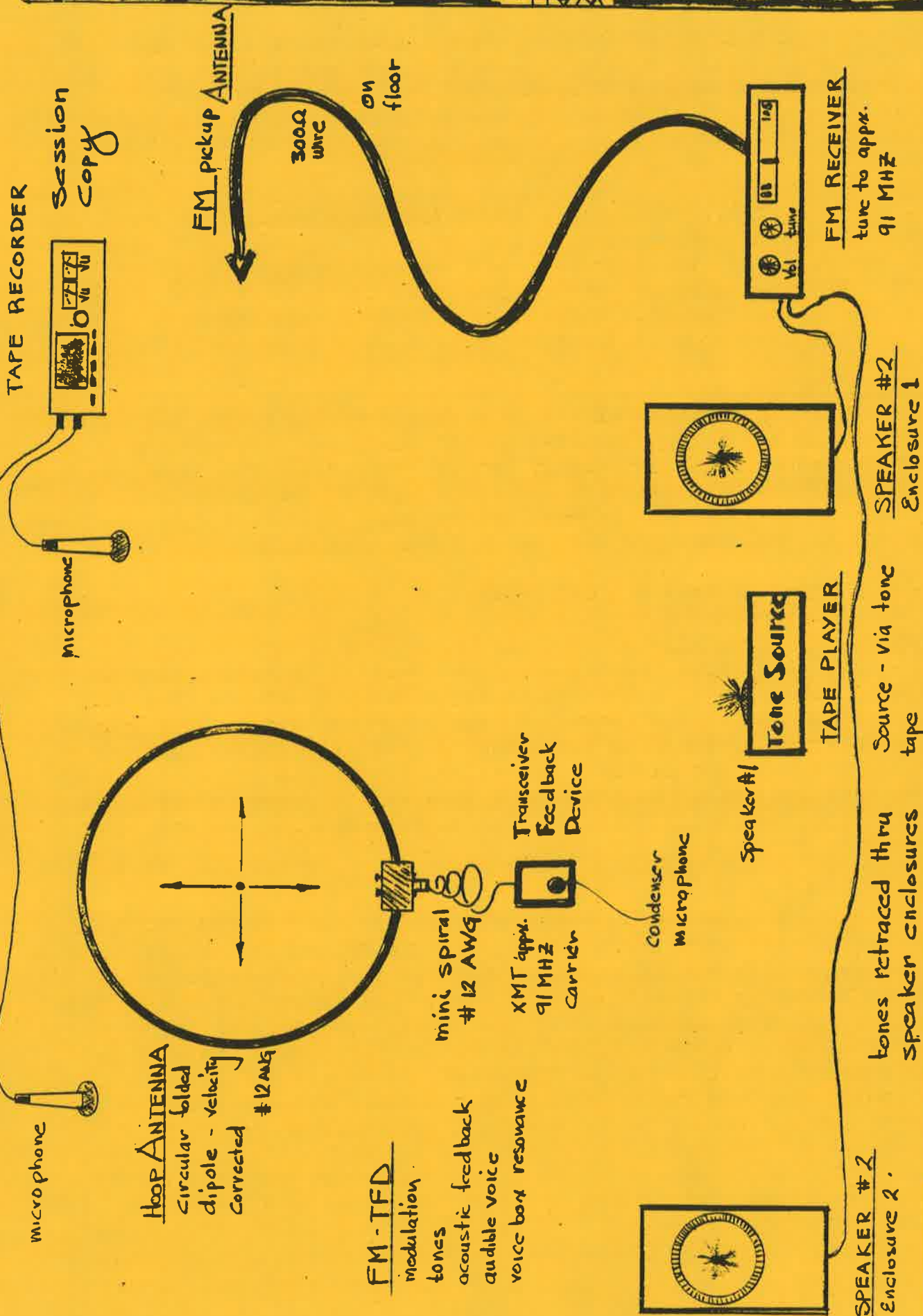

Figure 11D

MODE #2 Communications Set Up

tone harmonics via reflections - sound packet generation - harmonic formation

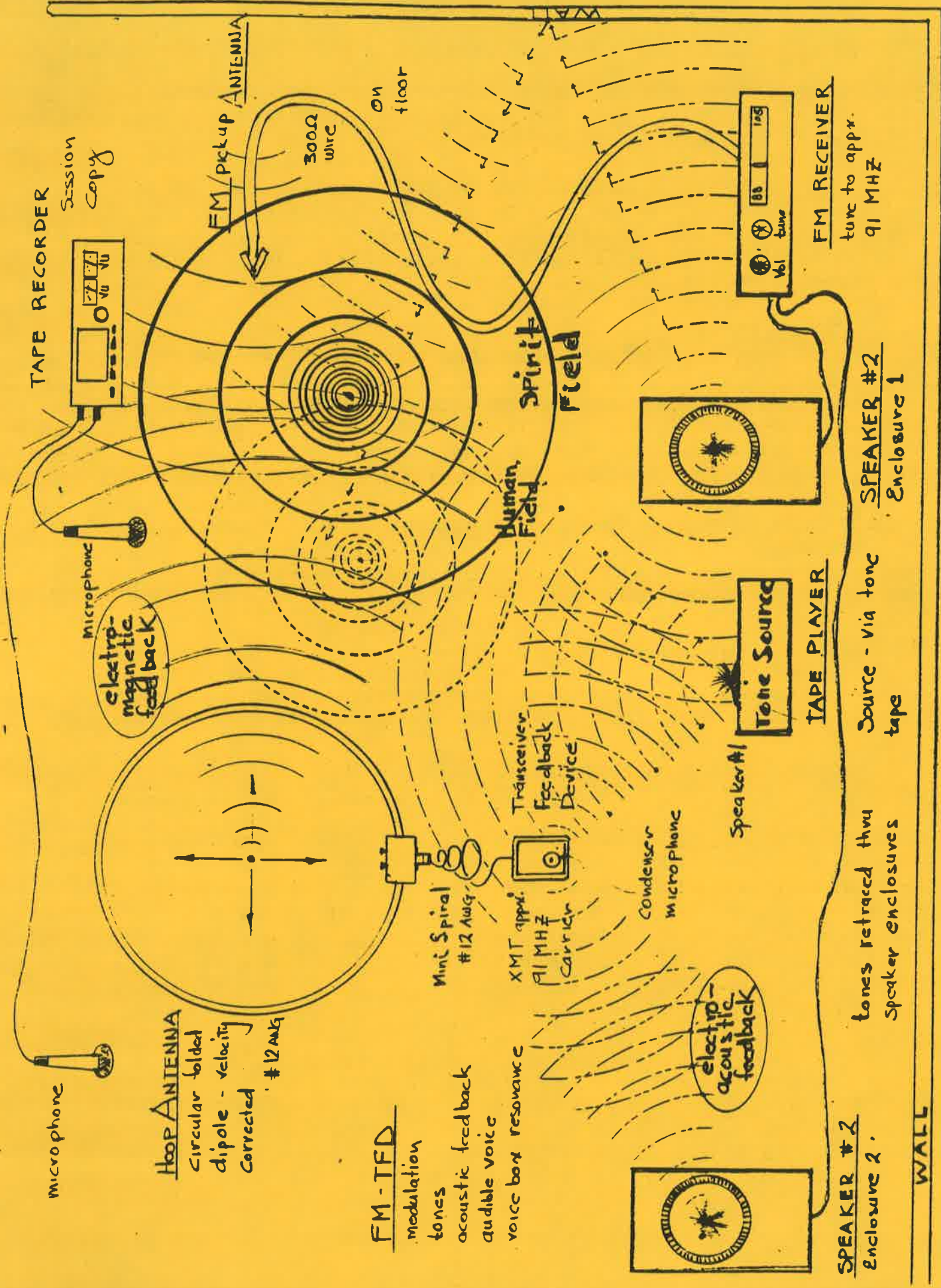

Figure 11E

MODE # 2 Communications Set up

picked up by the microphone or receiver of the FM-TFD unit. The tones modulate the 91.6 Mhz carrier, get picked up by the 300 ohm antenna wire (no special configuration seems to be necessary) and are played back via the two (2) speaker #2 enclosures driven by the stereo amplifier. The speaker's (#2) reproduction of the tones lags the source's production (spk #1) by some small time delta. This delay is significant and will be discussed under harmonic formation.

Another acoustic feedback is also quite active and that is the echoes produced by the non-anechoic properties of the lab itself. These tone reproductions also lag the source's (spk #1) production by an even greater time delta again making a significant contribution to the harmonic formation.

6.2.2 COVERT FEEDBACK

The covert feedback phenomena occurs between the earth plane participant (e.g. O'Neil) and the "balance" while an even more subtle covert feedback occurs between the astral plane participants (e.g. Mueller) and the "balance". This feedback becomes quite evident when some other acoustic tones take over breaking the "balance". It must be noted that different tonal qualities can be distinguished during these unbalancing durations and that they do not exhibit the stiff avalanche tonal rush. When you experiment with this system it will be important for you to distinguish the difference. We encourage you to "play" with this "balance" in mode #1 before getting into this second mode of operation.

6.3 HARMONIC FORMATION

The second key concept is harmonic formation. To nail down harmonic permutations becomes an interesting exercise to say the least. The following table will give you some idea as to its complexity.

<u>source #1</u>	<u>echo</u>	<u>source #2</u>	<u>echo</u>	<u>har. result</u>
speaker #1	_____	speaker #2	_____	set #1
speaker #1	Wall #1	speaker #1	_____	set #2
speaker #1	wall #1	speaker #2	_____	set #3
speaker #1	wall #1	speaker #2	wall #1	set #4
speaker #2	wall #1	speaker #2	_____	set #5
speaker #2	wall #1	speaker #1	_____	set #6
speaker #1	wall #2	speaker #1	_____	set #7,

etc.

Speaker #1 refers to the audible tone mixture (or source) from the tape player. Speaker #2 (note: there are two enclosures) refers to the audible tone output from one FM-rcv speaker. The second column in the table indicates what surface the first source is echoed from. As you can see, this tabulation gives only some of

the permutations. In addition to three other walls, we have a floor, a ceiling, other objects all mixing together with the output of three speakers. Harmonic formation now becomes self evident.

According to Mueller the audio tones emitted from the FM-rcv and the audio tone source (spk #1) set up additional harmonics including those from the walls (or room surfaces) with all speaker outputs. These echoed frequencies and source-to-receiver-delay combinations, produce a distortional effect. Mueller stressed that these additional frequencies are ABSOLUTELY NECESSARY to produce the frequency medium by which outside voices become discernible to the electronic circuitry or whatever recorder (this could be you) is being utilized. Further analysis can proceed along the lines of the tone lifetime. This lifetime or sound duration is directly related to the sound packet effect occurring within the echo chamber. The shorter the duration of the tone the more side lobes (so to speak) will be present in our plot of amplitude versus frequency. The more side lobes that are present or N_1^{th} harmonics the more combinations or superpositions of the N_1^{th} harmonics will form. Therefore all other tones can combine in this fashion resulting in a greater harmonic reach. We could also state that the purity of the harmonic formations would have much to do with the frequencies selected and their relative stability.

7. THE BRIDGE

With the two key concepts, feedback and harmonic formation, in mind an operational picture of the electro-acoustic subsystem develops. Paramount to the Mark IV system's operation is the super-sensitized energy bridge. Without this bridge, a communication is most unlikely. This represents the state of our understanding of the Mark IV interplane communication system as of July, 1982.

What is most interesting about the FM-TFD unit working in conjunction with the FM stereo is its ability to give the user a playground for the development of his/her more subtle energies and confirmation about other energies. If we simply retrace Mueller's vibrational evolution with the development of the more sensitive electronic equipment, we find a startling simultaneity. We must ask, are we witnessing an evolved SPIRICOM or are we witnessing a device more in tune with Mueller's "near end" vibrational level? In either case the greater sensitivity coincides with witnessing more subtle energies. And to witness is to have feedback. Because of the sensitivity and feedback nature of this balanced environment the earth plane participants can control the conductive shape (if you will) of the energy. For example, O'Neil was able to tune in FM stations outside the selected quiet point. O'Neil manipulated his energies (this took some practice within the playground) and changed the conductive patterns.

The idea of being able to change the conductive patterns presents an exciting range of possibilities for the researcher. It is also not too far-fetched to suggest that this ability to manipulate

and control the conductive shape can be used to assist our astral plane participants. (Some of our associates have entertained this idea.) And these same METASCIENCE associates have suggested that Mueller had this in mind when he introduced this system to O'Neil. Of course, assistance in this case would mean that the earth plane participant sets up the conductive pattern in such a way as to switch the bridge in line with the astral plane participant. Again, supersensitized "players" would be most valuable in obtaining constructive feedback.

-0-

The following parts list reflects the Mark IV system at the time O'Neil last had contact with Mueller.

1. FM-TFD unit
2. Circular folded dipole antenna
3. FM stereo receiver
4. Stereo amplifier & speakers
5. 13 tone tape
6. Cassette or reel-to-reel tape player
7. Tone manufacturing system
NOTE - A dynamic tone generator can be substituted for
5-6-7
8. 2nd cassette or reel-to-reel tape recorder
9. Compatible microphones for tape recorders
10. Room with non-anechoic properties
11. Two participants that strongly desire interplane communication.

Suggested techniques for constructing certain components on the above list.

1. FM-TFD unit
 - a) FM remote microphone (e.g. Mr. Microphone - Radio Shack) or
 - b) Modified Archer (Radio Shack) space patrol walkie-talkie. -- This transceiver is crystal controlled. You can gut the receiver portion and add your own version of a frequency doubler. The carrier freq. will be approximately 95-Mhz. We suggest using a frequency doubler to be adjustable within the FM band. Of course, if you could find a compatible crystal for the FM band you would have a simpler job. Replace the speaker-mike with your own choice of microphone. Attach the output to a mini-spiral antenna made from #12 AWG wire. It should be approx. 7" in height. Solder the free end to the center pin of a PL-259 connector.
or
 - c) Make your own version of the FM-TFD.
2. Circular folded dipole antenna.
 - a) The diameter suggested is 32 inches. You will need the following parts for construction:

- 8' 3/8" of black plastic 1/2" pipe
- 16' of #12 AWG copper insulated wire
- 1- 3 1/4"x 2 1/8"x 1 1/8" plastic box with cover
- 1- SO-239 chassis mount connector (mate for PL-259)
- 1- .001 uf capacitor
- 1- two lug screw type terminal
- Epoxy glue

Securely mount both the SO-239 connector and the terminal to the box. Solder wires and cap. (.001 uf) as shown in Fig. 11B. Epoxy 1/2" pipe to box as shown.

Comment by George W. Meek

It is obvious that the Mark IV system as it evolved during the closing weeks of the Mueller-O'Neil collaboration went far beyond the relatively simple system pictured in Fig. 11 of the SPIRICOM manual. It is also easy to see why, for a while at least, the Mark IV system could keep up with Dr. Mueller's increasingly higher or even more subtle energy level.

Just before Dr. Mueller's movement beyond the range of this improved system, he gave a few suggestions as to some additional concepts we might explore with the aim of "catching up" with him as he moved to still higher vibratory levels (as pictured in the "Many Mansions" chart). By the end of 1982 we hope that it will be possible to explore these new ideas. We will issue a further UPDATE should anything of significance develop.

In the meantime, we restate our position regarding Mark IV:

If you feel that you have:

- a. the necessary level of electronic knowledge and
- b. the necessary time and money and
- c. an intense desire and
- d. a physic person with a very high degree of what has been
loosely referred to as animal magnetism,

then by all means proceed to research Mark IV.

10.25GHz - 1977 and Continuing

Description and Theory of Operation

The purpose of this instrument is the testing and observation of interactions of spirit energies with electro-magnetic microwave energy in a more controlled manner than was possible with Mark II.

The instrument contains two Gunnplexers as a source of microwave energy. Their varactor-tuned-oscillators (VTO) operate at a nominal frequency of 10.25 GHz (the receiving unit) and 10.28 GHz (the transmitter unit). Figure 15 shows a cutaway view of the Gunnplexer without antenna. The main components in the oscillator cavity are the Gunn diode which will oscillate when supplied with 10 volts DC. Its output is approx. 15 - 25 microwave. A Varactor diode, when biased with a DC voltage (1 to 20V) tunes the cavity over a span of +/- 60 MHz. This is also the tuning range available at the I.F. tuning control on the front panel.

The cavity is coupled to a short waveguide that contains a very sensitive, low noise Schottky mixer diode. When the microwave energy generated by the Gunn oscillator escapes from the cavity and enters the waveguide, it passes by a ferrite rod circulator. The circulator samples a small amount of the signal and couples it to the Schottky diode. This mixer diode also furnishes the I.F. output for the instrument's amplifiers to be described later.

The antenna connected to the waveguide serves as a transmission and reception antenna (gain 17-db) for each Gunnplexer. Similarly, each Gunnplexer unit is capable of sending and receiving but for the purposes of this setup the I.F. output of the transmitter is not used.

The interaction of the two oscillator signals produces two major "beat" frequencies in the Schottky diode: a sum and difference freq. The difference frequency of 0.03 GHz (or 30 MHz) also is the intermediate (I.F.) frequency of the associated amplifiers.

Fig. 1. Cutaway view of the Microwave Associates Gunnplexer. Energy generated by the Gunn diode escapes through the iris of the cavity into a short section of waveguide.

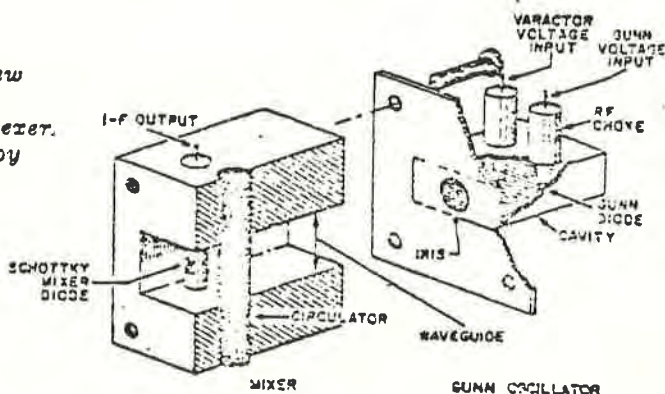

Fig. 15

* Trademark of
Microwave
Associates

We now had two carrier signals plus their sum frequency which together with their strong second harmonics should provide a broader area for spirit impingements. When the receiving unit is operated alone, spirit impingements ideally should be 30 MHz higher or lower than the 10.25 GHz carrier.

The receiving portion of Mark V consists of a low noise, high gain (90DB) I.F. amplifier with its own AM detector. The I.F. output feeds into a Limiter/Discriminator which serves as a demodulator for frequency modulations (FM). The outputs of both units is available at the front panel. Both amplifiers are calibrated for 30 MHz I.F. at a bandwidth of 10 MHz. Thus audio and video observations are simultaneously possible.

Drift and Voltage Regulation

After a Gunnplexer is initially turned on, its output frequency drifts rapidly as the unit warms up. The typical drift rate is about 300 KHz per degree Celsius. The Gunnplexer temperature may go up 10 degrees per minute after power is turned on, total frequency drift is 3 MHz or more. As the units reach thermal equilibrium, however, frequency drift slows and they will sit on frequency for hours at a time. To control drift and particularly to prevent the drifting apart of the two oscillators, their supply voltages have a common voltage regulator. Also the mounting of the Gunnplexers in the same enclosure assures the same rate of temperature-caused drift.

Tuning

The instrument allows a tuning range of at least 60 MHz for each oscillator. However, for practical reasons only the transmitter is tuneable on the front panel control marked "I.F. Tuning".

The front panel tuning meter provides an accurate means of tuning and zeroing to the center of the 30 MHz I.F. Freq. The tuning range is wide enough to observe also the I. F. "Image" frequencies. Switch on the 1 KHz test tone to aid in correct tuning and to help in the most efficient aiming of the horn antennae.

.....

Present Status (February 1982)

As of the time this first edition of SPIRICOM goes to press, we report that with Mark V we have not been able to establish voice contact with our intended collaborators on the mental/causal level -- depicted in the large diagram, "IN OUR FATHER'S HOUSE THERE ARE MANY MANSIONS."

The reasons for our inability to achieve such contact are discussed at length in Chapter 9.

On the possibility that one of the researchers who reads this material may want to build and experiment with this device or some modification thereof we present detailed information on this and the following page.

Note

MARK V-A BLOCK DIAGRAM.

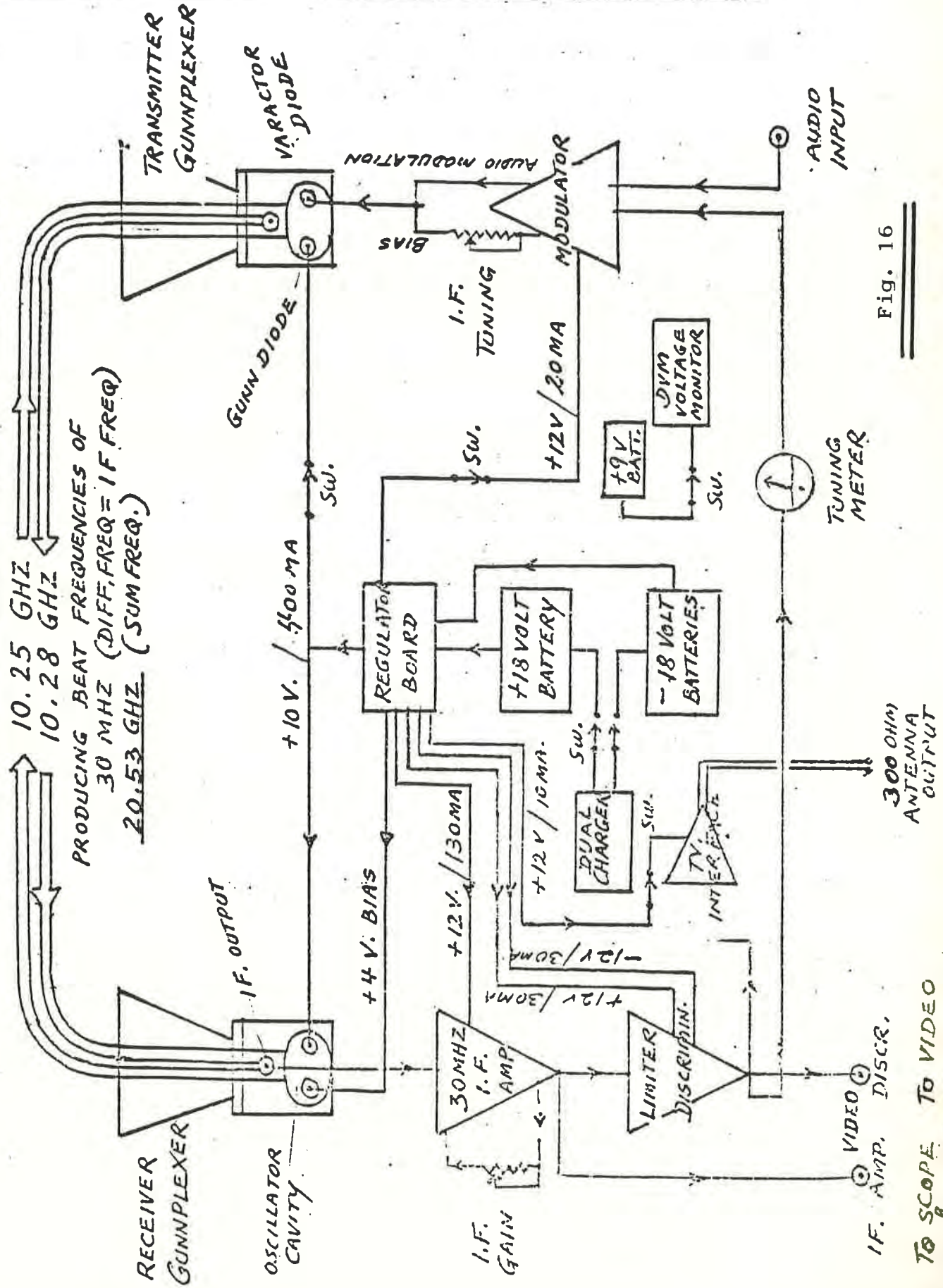

Fig. 16

TO SCOPE TO VIDEO

Vertical text on the right edge of the page, possibly a page number or reference code.



Fig. 17

Mark V

LESSONS FROM "DIRECT VOICE"

Any person planning to do research aimed at development of a SPIRICOOM-type system for talking to other levels of human consciousness should become familiar with the phenomenon of direct voice mediumship.

What is Direct Voice?

It is a method by which a person living on one of the astral planes can project his voice into a room where people can easily hear it and record it for future listening. The spoken words, in the best cases, will sound reasonably similar to the individual quality and inflection of voice the person used before shedding his physical body.

It is a method of communication that uses neither the medium's vocal cords nor his mind. The medium can, in fact, be playing cards, writing, knitting or carrying on a conversation with other persons in the room or even with the spirit person itself!

How is Direct Voice Possible?

It cannot be explained by modern science. However, the modus operandi has been known for at least 80 years and details of the process have been described by many communicators to listeners in different countries.

There are two crucial requirements. First there must be a person on the physical plane who has a particular cellular structure and energy fields which will permit the withdrawal of a material known as ectoplasm. (See Appendix C for details of the process.) Second, a group of persons working in the astral plane must use their specialized knowledge to process this ectoplasm and mold it into an etheric object that can function as a larynx (voice box). The spirit person who wishes to speak, places his face into it, and is told to try to go through precisely the same process he previously used in the physical body. This involves thinking what it is he wants to say and then moving his lips to help form words, just as he used to do in everyday speech. He is instructed by his spirit helpers, "Try to lower your vibration rate so that it will be easier to speak." The resulting voice is often so natural that the speaker's friends recognize it immediately whether they are present in the room or listening later to a recording of the sitting.

(The tape supplied in the packet mentioned on page 10 contains samples of several voices produced by this means.)

When and Where has Direct Voice Occurred?

It has occurred at various times for at least 4,000 years. The Bible is replete with examples of prophets, sages and seers who "heard a voice." (See Appendix C.)

In the present century there have been only a few direct voice mediums. (See Appendix B.) The best known study of direct

voice in the USA was Edward C. Randall's report on the activities during the first 20 years of this century, of Emily French in Rochester, New York.* In 1905, he asked a spirit who was communicating through Mrs. French, "Tell us the conditions that enable you to speak." He received the following description:

There are in our group seven people,—all expert in the handling of the electric and magnetic forces, and when you and the psychic, Mrs. French, meet, the vital force that emanates from her personality is gathered up. We also take physical emanations—substances—from you and the others with you, while we contribute to the mass a certain spirit force. Now, that force which we gather and distribute, is just as material as any substance that you would gather for any purpose; it is simply higher in vibration. We clothe the organs of respiration of the spirit who is to speak, so that his voice will sound in your atmosphere, and when this condition is brought about, it is just as natural for a spirit as it is for you. You then have what is known as the direct or independent voice, that is, the voice of a spirit speaking as in earth-life.

While there are several good direct voice mediums alive in the world today, nearly all of them prefer to work quietly with only a few of their closest friends in sessions with other-world communicators. Leslie Flint, of London, England, has cooperated most fully with the public in serving as a channel for hundreds of communicators now living in the astral planes. For many years he sat at regular intervals to bring through information from other planes. (At the end of this chapter is a list of available tapes made during such sessions.)

How Valid is Direct Voice?

During the first half of this century numerous studies of direct voice were made by investigators such as Sir William Crookes of England, Professor Charles Richet of France (Nobel Prize winner in 1933), Dr. Herrard Carrington, Professor James H. Hyslop, and others.

In the case of the present-day experimentation with Leslie Flint, researchers proved beyond any doubt that the voices were not formed by Flint's own vocal cords. They poured a measured amount of red liquid into his mouth, sealed it shut with layers of adhesive tape and told him not to swallow even once during a lengthy talk by a spirit person. At the close of the talk they removed the tape and remeasured the liquid. They found no loss of liquid, indicating that Flint had not swallowed during the talk, thus proving that his vocal cords had not been used.

Equally convincing was the fact that an infra-red photo taken during a sitting showed a rather indistinct mass or "glob" about

*Randall, Edward C., THE DEAD HAVE NEVER DIED. London: George Allen & Unwin, Ltd. 1917.

two feet from Flint's right ear, precisely where the spirit communicator had said the voice box was located.

But perhaps the matter of validity is established in an even more telling way. Examination of hundreds of communications via direct voice in this century shows that they contain knowledge that could not presently exist in the mind of the medium, nor in the minds of the sitters, nor in any written records. For example, the communicators, collectively, present a coherent account of what life is like on the various planes of the Spirit worlds -- an account that differs from any published descriptions.

While the phenomenon of direct voice still lies outside the bounds of our present limited scientific knowledge, the reality of this remarkable and very useful communication system can no longer be denied.

The Significance of Direct Voice

Direct voice communicators, coming as they have over thousands of years, are valuable in three ways. First is their contribution to a conviction as to the reality of survival. Anyone who accepts the transmissions through French or Flint is no longer dealing with survival as a matter of faith or believing. Such a person has acquired the deep-seated conviction that comes only with knowing the reality of life after death.

The second value of direct voice communication lies in the great wealth of detail concerning the nature of life on the astral planes. No other source to date has provided as much distortion-free information. Only equally rare high-level "telepathic channeling" can screen out the "coloring" of any transmission that comes through a medium's mind.

The third value of direct voice communication, is that in studying the functioning of the etheric voice box we may obtain insights that will assist in perfecting SPIRICOM. We certainly are not likely any time soon to be able to take ectoplasm from a person's body and proceed to make an ectoplasmic voice box. (We know precious little about ectoplasm!) But if we look upon the voice box activity as an energy manipulation, we may have an invaluable tool to help us in planning our further research. Ectoplasm (energy in some form) is taken from the medium's body. This is combined with what the collaborators loosely call "chemicals" or "spirit energy." Thus it seems that the raw materials for the voice box are energy -- of a chemical or biochemical and spirit nature. The energy vibrations from the speaker interact with the energy vibrations of the materials composing the box with the result that the surrounding air is set to vibrating at frequencies which, when picked up by the human ear, are identifiable as speech of individuals.

An Electronic Thought Box -- Direct Voice of a Different Kind?

Now, turning to SPIRICOM. In Mark IV we are not using energy in chemical form. For many years creative thinkers such as Rudolph Steiner, G.I. Gurdjieff, P. D. Ouspenski, Walter Russell, George

de la Warr and others have said that all matter exists at different octaves -- different levels. For example, a bit of matter has attributes that can be considered in terms of color, tone, electricity, temperature and chemical nature. In Mark IV we are using energy in the form of electricity to create a radio frequency signal as a carrier. Then we take energy in the form of sound (of the same general frequencies used in human speech) and use the radio frequency signal energy to broadcast these sound energies into the room where our intended spirit communicator is standing.

One day when Dr. Mueller saw another spirit person standing in the lab -- a man who later identified himself as Fred Ingstrom -- he told Fred to go ahead and talk. (This was after Fred said he would like to.) We asked Dr. Mueller how he arranged for Fred to be heard on the tape. Dr. Mueller said the only things required are the desire, the movement of the lips and the same thought process used on the earth plane. He continued, "The movement of the lips is necessary to produce in the mind of the speaker (spirit) the conditions, the frequencies as we will refer to them here, electronically -- for want of a better word -- similar to the RF carrier frequency we are using at this time.

Fred said to Dr. Mueller, "But he [William] can't see me. He doesn't know I am here in the room."

Dr. Mueller replied, "It is not necessary that he see you. Just do as I say and he will know you are here. He may not be able to hear you immediately, but will, we hope, be able to answer you on this tape recorder."

Fred responded, "Tape recorder. What is that?" Later, when Fred did converse via SPIRICOM he said that he had died in a rural area of Virginia about 1830 -- which would explain his unfamiliarity with a tape recorder.

Later, getting more technical, Dr. Mueller said, (as reported in chapter 5) "The only condition necessary is the desire of the spirit person -- and on your end the constant application of the audio frequencies in evidence there, and of a volume that is normally available to you. It remains only that whomever here wishes to be heard may do so simply by talking. Of course you can't actually hear them (or even hear me at this moment) but the mechanics of the lip movement and simultaneously thinking (yes, we can and do still think!) are automatically conducive to clarity of speech. This is regardless of whether the initiating voice patterns be here or there."

It seems to us of great significance that Dr. Mueller specifies the same 3 requirements to talk through SPIRICOM that are stressed by the spirit persons when they explained the steps they must take to talk through the voice box.

1. Desire on the part of the speaker.
2. Movement of the lips.
3. Thinking what it is he wants to say, just as he did when in the physical body.

This certainly points to a strong similarity between SPIRICOM Mark IV and direct voice.

Thus we are perhaps justified in considering the point raised earlier: does our RF signal in the MHz band and the mixture of 13 different sine wave tones in some degree accomplish what the ectoplasmic voice box accomplishes?

We publish these ideas in hope that many other researchers will begin to study the direct voice phenomenon seriously. They may well provide some insights that will be of assistance in further development of SPIRICOM-type equipment.

We also stress that much needs to be learned about the part played by the medium's mental energy and the energy of the various layers of his aura, in this fantastically complicated situation. We need to know far more about what the spirit person speaking through Mrs. French 77 years ago (in the above quotation from Randall) was talking about when he used the expressions.... "electrical and magnetic forces...vital force from the medium... our contribution to the mass of a certain spiritual force."

Tapes listed here are available from Mrs. Gladys Hayter, 4 Holcombe Rd. Illford, Essex England. Phone 01-554-1449. Write for current prices. (Items marked with * include comments about passage to the Spirit world)

- | | |
|-----------------------------------|--|
| 1. Aundrel | 57. Dr. Cosmo Lang, 2 |
| 2. Elizabeth Garratt Anderson | 58. Dr. Cosmo Lang, 6 |
| 3. Queen Alexandra | 59. Dr. Marshall, 2 |
| 4. Mrs. Emma Harding Britton | 60. Stainton Moses speaks on teachings of Spirit |
| 5. Father Bernard | * 61. Charles Morgan |
| 6. Bimbo the Clown | 62. Music Hall Stars Short Tape |
| 7. John Brown, 1 | * 63. Marchisa |
| 8. John Brown, 2 | 64. Olson (a friend of Mr. Woods) |
| 9. John Brown, 3 | * 65. Father O'Leary |
| * 10. George Briggs | * 66. Alfred Pruchard |
| * 11. George Bakewell | 67. A Persian |
| 12. William Bayliss | 68. Pierre |
| * 13. Mr. Briggs | 69. Persian on Persean |
| 14. Brother Boniface | 70. Louis Pasteur |
| 15. Mon. Charles Bonure | * 71. Mary Ann Ross |
| * 16. Edward Ted Butler | 72. Bro. Pickett |
| 17. Lord Birkett | 73. Rose, 1 |
| 18. Lord Birkenhead | 74. Rose, 3 |
| 19. Lionel Barrymore | 75. Rose, 6 |
| 20. Confucius, 2 | 76. Rose, 7 |
| 21. Chopin, 1 | 77. Dennis Scott, 1953 |
| 23. David on Rescue | * 79. Roman Soldier |
| 24. David on the Voice Box | * 80. Bessie Smith |
| 25. Sir Arthur Conan Doyle | 81. David Scott, 1966 (he swears) |
| 26. Dr. Docherty (a poltergeist) | 82. David Scott, 1971 |
| 28. Rev. Featherstone | * 83. Willi Schultz |
| * 29. Ellis (the Hangman) | * 84. Dr. Carl Schültz |
| * 30. Evans (a Welshman) | 85. George Bernard Shaw |
| 31. George Harris | 87. Ellen Terry, 2 (actress) |
| 32. Elizabeth Fry | 88. Ellen Terry, 3 |
| * 33. Albert Frost | * 90. Harry Tuckett (a highwayman) |
| 34. Will Fife and Aundre | 91. Tagore (an Indian Poet) |
| 35. Mike Fearon, 3 | 92. Rev. Drayton Thomas, 2 |
| 36. Mike Fearon, 4 | 93. Rev. Drayton Thomas, 4 |
| 37. Mike Fearon, 6 | 94. Rev. Drayton Thomas, 6 |
| 38. John Grant | * 95. Bobby Tracy |
| 39. Mike Fearon Speaks on a Monk | * 96. Timothy |
| * 40. Dr. Ann Gaster | 97. Sir Henry Beerbohm Tree |
| 41. Guiseppe (an artist) | 98. Queen Victoria |
| 42. Gandhi | 99. Isaac Watson |
| 43. William Randolph Hearst | 100. Oscar Wilde |
| * 44. Harry | * 101. George Wilmont |
| * 45. George Hopkins | * 102. Jenny Wilson |
| * 46. Alfred Higgins | * 103. Wagstaffe |
| 47. Holman Hunt (an Artist) | * 104. Nellie Wright |
| 48. Mickey & Dean Inge | 105. Sounds from Jack Walker Circle |
| 49. Sir Henry Irving | 106. Wilberforce, 1 |
| * 50. Jeremiah (a Roundhead) | 107. Wilberforce, 2 |
| 51. Bro. Josephus | 108. Stephen Ward, numbers 1 to 11 |
| 52. Bro. John speaks to Mr. Woods | 110. Mickey on Truth of Bible |
| * 53. Johnson, 2 | 111. Mickey on Spiritual Teaching |
| 54. Sir Oliver Lodge, 2 | 112. Mickey on Abortion |
| 55. Sir Oliver Lodge, 3 | 113. Ruper Brooke |
| 56. Osbourne Leonard | 114. Sammy |

Additional titles MAY still be available from:

- | | |
|---|-------------------------------------|
| 1. John C. Burley - Ph: Brighton 594547 (std code 0273) | 2. J. Rabinowitch - Ph: 01-486 2068 |
| C. Eng. - M. I. Mech. E. | M. B. - D. M. R. E. (Cambridge) |
| 47a Southwick St., Southwick Brighton | 5 Cambridge Gate |
| Essex BN4 4TH ENGLAND | London NW1 4JR ENGLAND |

SPIRIT ENERGIES

Their Nature and Problems for SPIRICOM Researchers

The reader was served notice on the front cover of this booklet that what was to be presented was not a strictly electromagnetic communication device following in the line of the telegraph, telephone, radio and television. The term "An Electromagnetic - Etheric Systems Approach" was chosen with good reason. Our research indicates that it is very doubtful that any system based solely on an electromagnetic approach will successfully communicate with the interpenetrating Spirit worlds.

The reason for this opinion is obvious: Science has seen no evidence that the worlds of Spirit exist. It is equally obvious that there have been few if any occasions in which happenings in the worlds of Spirit have interacted with any wavelengths of energy at any spot in the complete electromagnetic spectrum as it presently is known. Hence, says science, spirit energies do not exist, and anyone who thinks otherwise is naive, misled or just plain crazy.

Well, our researchers on the small Metascience team do not object if they are considered crazy. We said on page 9 in our Preface, "We are quite content to leave judgment on all such matters to the unfolding of history in the 21st century." Our good scientist friend who has been living in the worlds of Spirit since his "death" in 1967 has said so often, via SPIRICOM, "Well, lets get on with it!" So we will proceed to share with all other interested researchers, hard-won knowledge on the subject of spirit energies which has been given to us by scientists now living in the worlds of Spirit.

Let us first identify and introduce a few of our good friends with whom we have been in frequent contact since 1972. We explained in the opening paragraph of Chapter 4 how we came into contact with Dr. William Francis Gray Swann. Take a moment and get acquainted with the qualifications of the leader of our team of fellow researchers:

Swann (awon), William Francis Gray. b. at Ironbridge, Shropshire, England, Aug. 29, 1884—. English physicist working in America, known for his investigations of cosmic rays. He was assistant lecturer and demonstrator (1907-13) in physics at the University of Sheffield, served as head (1913-18) of the physical division of the department of terrestrial magnetism of the Carnegie Institution at Washington, D.C., and was director (1927 *et seq.*) of the Bartol Research Foundation of the Franklin Institute, where his researches centered mainly on thermal measurements, electroconductivity, relativity, atomic structure, and atmospheric electricity. He was professor of physics at the University of Minnesota (1918-23), Chicago (1923-24), and Yale (1924-27), where he also directed the Sloane Laboratory.

Dr. Swann and his collaborators live mostly on the Mental and Causal Planes as depicted on the "Many Mansions" diagram. When souls have evolved to this level they have shed most of their personal ego. In fact, in speaking with them, an effort must often be made to get them to reveal the personal identify they had when they were in their now discarded physical body. We had been working with Dr. Swann's team of more than 200 members for a few years before we learned that it included these two distinguished contributors to the development of radio.

DÉ FOREST, LEE (1873-1961), an American inventor, pioneered in wireless telegraphy and radio broadcasting. He obtained patents on more than 300 inventions. He patented a vacuum tube called a *triode*, or *audion*, in 1907. It often is described as an invention as great as radio itself (see VACUUM TUBE). The vacuum tube, which amplifies weak sounds, was basic to the development of long-distance radio and television communication.

De Forest staged the first musical radio broadcast in history from the Metropolitan Opera House in New York City in 1910. He designed and supervised construction of the United States government's first high-powered naval radio stations.

De Forest moved to the Pacific Coast in 1911. He became interested in sound pictures and diathermy machines. He worked on methods for photographing sound waves on motion-picture films. He was born in Council Bluffs, Iowa.

Fessenden, Reginald Aubrey (b. Oct. 6, 1866, East Bolton, Que.—d. July 22, 1932, Bermuda), radio pioneer who broadcast the first program of music and voice ever transmitted.

After study at Trinity College School, Port Hope, Ont., and Bishop's University in Lennoxville, Que., Fessenden went to Bermuda as principal of Whitney Institute, where he developed a scientific interest that led him to resign and go to New York, where he met Thomas Edison and soon became chief chemist of the Edison Laboratory at Orange, N.J. In 1890 he joined the Westinghouse Electric and Manufacturing Company and in 1892 turned to an academic career, first as professor of electrical engineering at Purdue University, Lafayette, Ind., and then at the Western University of Pennsylvania (now University of Pittsburgh). There he worked on the problem of wireless communication.

In 1900 Fessenden left the university to carry on experiments in wireless telegraphy under

the U.S. Weather Bureau and in 1902 organized the National Electric Signalling Company. Under his direction, the production by engineers at General Electric Company of an alternator with the high frequency of 50,000 hertz (cycles per second) made possible the realization of radiotelephony, and Fessenden at once built a transmitting station at Brant Rock, Mass. On Dec. 24, 1906, wireless operators were startled to hear speech and music coming in over their receivers. The same year he established two-way transatlantic wireless telegraphic communication between Brant Rock and Scotland.

Fessenden's chief contribution to the further development of radio was the heterodyne principle, in which the incoming radio frequency is converted to an intermediate frequency that is more easily controlled and amplified.

In addition to his achievements in radio, he invented the radio compass, the sonic depth finder, submarine signalling devices, and turbo-electric drive for battleships.

Dr. Swann's team also includes former mathematicians, chemists, physicists and biologists as well as two very helpful technicians who say they worked for many years in the research laboratories of the Bell Telephone Co.

As the years passed, we added greatly to our understanding of the tremendous difficulties which face any earth-side communications researcher trying to make an instrumental contact with entities living on higher levels. And, what is equally surprising, our researchers in Spirit, highly intelligent as they are, know relatively little about the nature of the energies in which they live and move and have their being!

As we see it, the crux of the problem of building a workable instrumental communication system, free of any medium, is easily stated in these deceptively simple terms: From our side, all we need to do is to learn how to build an instrument which will provide an interface between the kind of energy they have available, and the energies we know and can manipulate in the electromagnetic spectrum. Yes, it is that simple. And that is the sole purpose of the research projected in Marks VI, VII and VIII.

It will sound like science fiction to the uninitiated reader of these pages but we must point out still one more complexity. Dr. Swann's team must design and build instruments which will manipulate the subtle types of energy at their disposal and impinge them on our transducer! After our many years of collaboration

they feel that they are far along in their own research. Like us, they have built many pieces of experimental equipment.

Specific Information on Spirit Energies

We feel that it will be useful to researchers who want to benefit from our pioneering studies to know something about the types of information we have gleaned in our work with the Swann group. We have gone through the many dozens of transcripts of our conversations with Dr. Swann and his teammates and in the remainder of this chapter present pertinent excerpts.

[Important note: The remainder of this chapter contains telepathic not electronic communications, but the conversation is about the latter. It is well worth the reader's effort to accommodate to the unusual sentence structure of the communicators from the worlds of Spirit. We have refrained from any editing of Dr. Swann's remarks.]

Ques. -- Have any of you monitored the work that is being done by Jurgenson in Sweden? Does that have any relation to what we are attempting to do here? He is operating between 1500 and 1600 KHz on the broadcast band.

Dr. S. -- They are working in an altogether different level of existence than we are. You will find, as I said, that we have gone beyond the use of the energy in forming words but we work with the power of intelligence, the energies of intelligence. It will not be as easy as it is on lower frequencies where the energies are expressed in sound.

Now there has been help set up for these on the lower frequencies who are trying to make a breakthrough into communication with your dimension. Help has been given them in the form of stations of power on their level where they can amplify the voices they have, the words they can enunciate. We noticed as we studied these that they are invariably monotonous and faint...The stations that are set up are designed to furnish energy to amplify these voices, to create a power by which they may be more easily heard. There are certain technicians who work with these. You see, the desire, the great desire to communicate with your world, your form of life, is so great that it has created what breakthroughs there are...And breakthroughs will continue as long as there are dedicated ones who will pursue this. There has been more accomplished than has been told.

Ques. -- The source being so much lower, is that correct? The source of communication?

Dr. S. -- And the power that is being used. We could not through this source give you what you desire and what you wish. Working through the best human instrument, if we are lucky, 80% of our real meaning is given... But with what we are projecting and what we are working to manifest here in our level will be something that the words, phrases, the complete gamut of intelligence

can pour through and come out as clearly recognized. At least this is our ideal, that from one who works on higher levels, the tremendous knowledge acquired can pour forth to be a blessing to many on your level...

[Nov. 1975] Our experimentation with an audible voice is still in the process of manifestation. Our activities have resulted in the taking apart and putting back together many times, our concept of the impingement of the "voice." We are able to put the frequency upon the spiral* to a certain extent in trying to transpose, not to communicate in code, though this may be a possibility. The problem is to put the frequencies together to produce the voice sound...

We have left behind shall we say, on lower levels much of the use of the so called voice. Our work is done mainly through thought or mind energies. We will call it thought because that is how you understand it. But let us say that these are mind energies directed in a certain focus or a certain pattern. There can be the combination of certain energies to create what you call voice. And that is the problem we are dealing with right now. There are three or four notes that are the basic notes to put together to create sound on our plane. Our work now is to evolve the combinations of these sounds, the universal notes, to approximate what you call voice so we may communicate. And then the problem is how to change this in such a way that we may put the actual sounds upon this energy spiral. We have a certain concept of how we are going to do this. We have four groups working on this at present. We have been satisfied with our ability to impinge upon your (1200 MHz) signal or as you say to modulate it. We could carry it on and communicate with you by code but that is not our primary object.

Our friends ceased working with our 1200 MHz instrument and concentrated all their efforts on the solving of other problems that seemed insurmountable. In April 1976 our small lab was closed and all equipment moved to new facilities in Ft. Myers, Florida. Work continued on several other interesting developments in the area of spirit detection. However, our planning of better spirit communication equipment continued. We kept in touch with Swann's group through occasional sessions with our excellent medium. We even found a way to bridge the distances between us. How would you conduct a trance session when the medium is in Arkansas, one researcher at the lab in Ft. Myers and two other researchers in Pennsylvania? Very simple. We supplied each party with special telephone amplifiers and through a conference call at an appointed time, the session went on as usual. A friend of the medium assured that things went smoothly at that end. Also tape recordings were made from at least two locations. Much valuable material was received in this manner and some interesting exchanges took place. Actually the sessions were a bargain as the phone company did not have any higher rates for "inter-dimensional" conference calls!

*The spiral is a combination of spirit energies explained in more detail below.

During one of these sessions the telephone lines even became a testing grounds for spirit energy impingements. Two technicians in Swann's group were testing their ability to apply spirit energies to various electro-magnetic equipment in the physical dimension, such as radio station transmitters, TV and microwave transmissions, Ham transmissions, etc. They wanted to see the interaction with electro-magnetic energy. And interact they did, indeed! We have on tape two long distance calls these two fellows turned into a disaster. I played portions of that tape to telephone experts who have no explanation for this kind of "interference." The energies used were the same spirit energies impinged on our own equipment in a much more controlled manner. But let our friends speak for themselves in their attempts to explain this spirit energy to us:

Gilley, -- [one of the "technicians"] -- I want to say that to find the common term, let's use the word spiral. It is necessary when we work with this type of energy to organize it. We have two types of energy....Both of these are necessary because of the balance that we need to use in an organized form with enough force to affect a material piece of equipment. The spiral form is an interwoven, forceful energy combination which sweeps spirally from large to small diameter. And anything that you have seen on your print-out sheet (or heard in your equipment) is caused by only a portion of the arc of such a force of two energies which, intertwined, can then be directed. As we cut it from the original we can direct it in any fashion or any grade we wish.

We have not always been able to do this. This is the way we did the telephone conversations. These two energies are both common to our plane of existence....The equation that Dr. Smith gave you postulates these two energies. He has called them universal sets. By that he means that each one of them is a completeness in itself and beyond the count of the energies of this particular type of movement there is no other in our area. It is a complete set and we call it "universal" because it is one of the fundamental energies in our plane of being...

With the two together sparking each other we get a complete spiral and as I just told you we use only portions of an arc of the circumference in order to try to affect your equipment which responds to direct force instead of circular force....

Ques. -- Mr. Gilley, you mentioned two forces and you mentioned spirals several times. Would it mean something to us if those forces were combined into what we would term a vortex and then you would use the vortex as the way you impinge it on our dimension?

Gilley -- Why yes, definitely. Remember we are not using the complete amalgamation of forces. We are only able at this time to use a portion of a circumference, an arc of the beginning of it, but as the vortex narrows the force increases.

Ques. -- That is where they become united and directed to where you want them to impinge?

Gilley. -- Yes.

Meanwhile, a parallel development between one of our associates and "Doc Nick" had resulted in the first sustained two-way conversation via electronic equipment. Should we abandon our efforts of communication with higher levels to work in an area where the problems seemed less difficult? We decided to continue with a fresh approach which was sparked by two sessions with our medium in March 1979. In these sessions our collaborators explained their own task more clearly and dropped some suggestions for us. Here are portions of that session:

Dr. S. -- We are faced with conversion of a highly energized stream of "neuro-electrons," you call them photons. We need to convert this and to find a definite carrier wave on which we can superimpose the vibrations of our thoughts which at your end of the communication link can be received and recovered by any possible means.

Elaborating more on the available spirit energies Dr. Swann said:

Dr. S. -- From the standpoint of comparison with the energy of the electrons that you are working with we would say that it would run perhaps 20,000 Megacycles (20 GHz). We cannot designate it that because it is not the type of electrons you are familiar with.

A member of the team, T. A. Fessenden had some suggestions:

Fess. -- The problem here is that of the deceleration of the energies. You have nothing there, such as a tube, which could receive this rush of energy and put it through a "converter" to step down the frequency and slow it down. It is going too fast for any machine that you have, to step down the frequency so that then it might be amplified and the signal could be made audible by whatever means you would want to use.

Ques. -- You mentioned a tube. Can you describe this tube, or tell us what the function of the tube is?

Fess. -- Well it would be something as you use in your test equipment (oscilloscope) here to receive the neuro-electrons as they arrive and then compress them and slow them down....let me say that in our equipment we will have provisions to arrange them in orderly pattern according to the pattern we wish to impress on the energy. We can arrange it and as we use it... it is in frequency with us...you understand.... It is in frequency with us, we relate to it. But we cannot slow it down.

The following remarks of Dr. Swann best describe the spirit of cooperation and scope of inter-dimensional communication. Little can be added to it and it is given here in its entirety:

Dr. S. -- Now gentlemen, you know that in a laboratory where one does experiments and measures results, these must be done over and over; and results compared; and the work continued until

the problems are solved. The development of the present electronic age on the physical plane of this world did not come about in just a few short years. It was step by step and use by use until out of the problems of the appliances in use, grew the understanding of the greater development. Then came the bringing of the greater development into being on the physical plane and the change of the appliance with the cooperation of that development which had been pioneered and tested over and over and over again.

I might say that only under the conditions of great stress of necessity, are inventions born of short time and intense effort. This we have not been able to accomplish even with the intense effort we have put into this in all our groups each working singly and collectively in this area. We now have the knowledge of how we may use the energy on which to impress the thoughts or signals. Our concern and Fess's concern and Lee's concern is this: As we are able to control the energy, it may come to your instrument with too much force and needs to be further controlled so the power will be reduced, as it were, intensified and reduced. Then what we have impressed upon it shall be made into sound and can be recorded. Ultimately, as we see it, the energy can be given in such a way that a sentence spoken on your equipment can be heard in our dimension.

The machine in the laboratory in Philadelphia was a great revelation to us. Our domain has been invaded from time to time by much of this type of thing, except it was foreign and we have taken all means possible to exclude it from our area. Most of it is very disturbing. We also might mention that we are troubled in some instances by what we call the "cling-along" phenomena. The energy that we use, as it rushes through our rarified area creates what you would call static. We cannot entirely eliminate it. We have short vibration transmissions going on all the time with the various models we have made. The principle model on which we are working is that which is designed to connect with what you built yourselves. We have considered all the various possibilities. With Fess speaking to you and others of his knowledge and ideas, it is as if someone were speaking to you in Swahili in attempting to explain the working of a foreign instrument you have never seen and have not been able to visualize. We regret this very much. Perhaps we might say this: The experiments we have done in cooperation with you have been in our opinion very successful. We were able to repeat the experiment of impinging energy upon your detecting machine as you recall. This occurred in one session and you asked for it to be repeated and it was repeated in another session.

We have been able with the efforts of Barnes and Gilley and their team of technicians to look into communication devices and transmission principles which are being used in your world now. We also are quite familiar with many of these because as we mentioned to you before, most of these things which are brought into manifestation on the physical plane of existence come directly from technicians, engineers, scientists, doctors, teachers,

philosophers and various other teams on the vibrational, you might say inner planes of existence. They have already been visualized and pioneered and given in whatever form of development is considered possible to transmit to persons on the lower planes. The latter is usually not done in team work in laboratories but individually to the experimentors a little bit at a time. Lee DeForest himself, was one of those for whom the light shone in the early days of communications. Without his ability to tune in to the higher realms much of the vast network of communication across the world would not be possible today.

These ideas and ideals pioneered and perfected to the extent we are able to, in whatever realm of civilization or culture exists, are always added to by further inspiration. In this conscious cooperation with you we are attempting something which our group has never attempted before, namely to work on two planes, you on yours and we on ours and put our work together in such a way that it will manifest physically and on our plane in a massive communicating device which will transfer communication directly.

We had never gotten into the ramifications of such an extensive project before. We are confident that it can be done. As mentioned, we have spent these years in intensive research. In our mathematical department we have explored every possibility of the rhythm and harmony of the numbers it has required to fulfill such a project. In our engineering department with Lee and Fess in charge we have gone further in the building of the device we ourselves will use than had been deemed possible in such a short area in the arc of time. Remember now that I am saying we have never before built, nor has there been built in this area a device which is to remain in this area and be used in conscious cooperation with a device upon the physical plane of appearances. Now this is something most unusual! This marks an epoch in the relationship of the inner plane of life in which we live, and you, on your plane of existence! This is a conscious cooperation across the boundaries of the inner dimensions and into time and space! Consider that the instrument we are building here will remain here and will be experimented with and will be modified, further developed and come into a consciousness of comprehension between us and you. All that is lacking now is our further perfection of our instrument and the control of the energies we must use.

As Lee tells me we also have the design now of a carrier wave upon which we may be able at some future date to place a controlled amount of the moving particles of the neuro-electronic type of energies in order to step it down and slow it down. (He had intended to explain this last night if there had been further time.) Now since our machine will not come into manifestation on the physical plane, we have been at pains to consider how we might best explain to you the receiving of this energy and how it may be brought into sound. We would ask you when you have the time, to examine very closely the receiver of the telephone you use daily and see if its means of receiving sound would suggest any ideas to you!

Dr. S. --[continuing at a later date] This machine, as Fess told you, we have considered and visualized as directing a stream of energy (consisting of extremely fast moving energized particles) into something of a "tube." This tube might further compress the energy into some sort of a rectifier or "decelerator" which might slow it down sufficiently so as not to burn out any of the devices and materials you are using.

We would like to leave with you the ideas that Fess gave to you. We do not feel it necessary at this time that Lee should speak to you. I believe I have covered most of the areas of the actual machinery. Bear in mind that I have said the machine we have built on our plane is a transmitter type of machine and a receiver type of machine. There are many bugs in it so we must go over it again, but it was capable of being experimented with.

We were very pleased with the machine built in Philadelphia and we did many experiments with it at the time that it was turned on. We did not feel it necessary to confuse you with leaving the actual track upon the machine. So we wiped the tape clean because there were certain things on there which you would have been puzzled to understand and would have taken perhaps a great deal of your time and resulted in frustration. But they meant something to our technicians..so we wiped it clean in order that you should not be confused.

We were greatly appreciative of the opportunity of this beam of energy which came into our area in such a way that it was not disturbing and was clear and easily worked with. Therefore we decided after the numerous experiments I have mentioned that it was not necessary to continue with it except from time to time to go back to work with this when something came up which we needed to clarify. Therefore our earlier request for the machine to be left on after it was moved to Ft. Myers.

Now I will remind you that there are many across the world working on this very same idea on which you are working. Many of them are of scientific mind who will experiment over and over again, write down results; compare results and go on to other things with which they may compare and contrast these results. Anything that is done in a tremendous hurry will show the results of the haste. And as I have told you there are many other areas of the inner dimensions which we inhabit and where much experimentation is going on in every field of human interest, be it machinery, communication, philosophy, mathematics or any other field. These are working not for gain and not for glory but for the benefit of their brethren and their way of life and their help and cooperation upon the material plane of life. It is work for the pure joy of working and for the perfection of something which can come into being in a helpful manner for those of us who are still struggling with the vicissitudes of life on the material planes.

This unselfish labor done for the joy of labor and the joy of accomplishment is not given for the material benefit of anyone. There are people in some countries who seize upon developments given for the benefit of mankind and then manipulate their use for their own gain. We cannot help but speak of the year 1912 when our friend Lee, who had perfected something which made possible the great network of long distance communication across the world, did not receive from the great company which owns most of these communications systems today, sufficient pay for his time and his devotion. He received but little for his years of experimentation and intense dedication. A team in our area helped him develop this little device without which your network of telephone communication today would be impossible.

This same grasping for material wealth still exists on earth among those who have not progressed above the lower levels of consciousness. It is a fact, and we who have escaped its grasp and have gone on to greater things can only give the benefit of our attention to these developments which we believe would contribute to greater understanding among those who are lower on the scale of evolution; greater happiness to those whose hearts are bowed down in sorrow and grief for the loss of loved ones; and greater development and knowledge to those on the material plane who are dedicated to the pursuit of knowledge, wisdom and understanding in every field of human endeavor.

We visualize a vast network of communication through all the "many mansions" or levels of consciousness associated with planet Earth. Eventually we visualize this network of communication spreading into the inner dimensions of other worlds where speech is not as it is on the earth planet and where form is not the same.

All creation must come to the realization that all are ONE. That there is no difference in any being and that all are parts of each other. All together through all the worlds and different suns and their solar systems all are part of the whole. And that whole is the one-ness of the All.

Since we have undergone a second death and rebirth to our present level of consciousness, it is natural that our philosophy has been expanded. Here work is for the joy of accomplishment and for the good it may be for those on the lower planes. We are aware, as you must be aware that all things must come about through patience, through testing and retesting and planing and laying aside the planes for other planes and going back to the drawing board. It is a continuous effort and before the effort is made there must be a tuning in and an asking for the individual inspiration as well as seeking it through the direct communication with us. It is possible that you are right on the edge of a breakthrough at the present time and you do not as yet know it because you have not asked!

We would also like to remind you that there are many who are pioneering the electronic means of communication and surely,

surely these devices will be of great comfort to many who are not knowledgeable about the inner worlds or the differences in the vibrations of the inner dimensions of this planet. There are some devices already conceived which pioneer on the lower levels. If you truly feel within the depth of the I-Am-ness that you are, that this is the way for you to go, then we are happy for your decision and we will wait patiently while we test and retest and build and rebuild and apply and reapply the principles we know and which we are endeavouring to discover as more perfect usages of the energy; and that we do not know, for we do not know many things as yet. This work we do is for the purpose of our learning also. We will wait patiently and allow you to experiment and joyfully bless your efforts.

-----O-----

Hopefully, the nature and the quality of this small sampling of the information transmitted by Dr. Swann will help the reader to realize the largely untapped accumulation of knowledge available to earth Man from the mental and causal level of consciousness. This can be tapped by the individual seeker working alone, provided he is mentally, emotionally and spiritually evolved and goes into deep meditation day after day to earnestly seek enlightenment. It can also be tapped through the services of the very rare type of medium or telepathic channel who has a guide, helper or control sufficiently evolved to personally span the great differences in energy levels from the mental-causal level to the bottom of the astral levels in which live all of us still in physical bodies. (See the "Many Mansions" chart.)

GUIDELINES FOR FURTHER RESEARCH

From the perspective of a decade of intensive research, several points of importance are apparent:

1. Our effort to collaborate with scientists who have made the transition through the door marked "death," and who are willing and anxious to collaborate, has resulted in significant progress. Only with their help have we been able to achieve our initial successful two-way conversation. Such instrumental communication is now firmly written on the pages of history.

2. Our original conviction seems to be confirmed, that, for conversation with the mental and causal plane, we will have to operate at frequencies above 1,200 MHz.

3. The tremendously valuable flow of information from Dr. Mueller indicates to us that it may be possible to communicate well up into the middle astral with a device roughly similar to Mark IV, operating in the 25 to 35 MHz frequency range.

4. Our very sporadic results with Mark IV and our inability to replicate spirit contact in other geographical locations and with other operators, indicates the need for extensive additional research with MARK IV. We must further identify and establish the missing parameters. Item (3) above indicates the great importance of further research with this type of equipment. (Note: Recent research indicates that equipment for Mark IV can be made much simpler and less expensively than our present lab system. It has a fascinating potential for miniaturization.)

5. Analysis of the Leslie Flint direct voice tapes shows that quite high level communicators -- probably on what we categorize as the higher astral -- have been able to communicate via a special technique. They say that they have forced themselves to lower their vibrations in order to speak through the ectoplasmic voice box. It seems possible that they may be able to accommodate themselves to taking on the heavier density (lower vibrations) necessary to communicate at say 30 MHz via a much improved Mark IV.

6. Research is urgently needed to further investigate the role (if any) of energies emanating from the equipment operator(s) or the direct voice medium. Are such energies from the aura of the operator or from his mind, or both?

Similar studies are needed to determine the possible influence of monthly lunar energy forces, environmental and diurnal influences. (Doc Nick and Dr. Mueller most often came through just before midnight until several hours after midnight. Jurgenson reports best reception during full moon - the time at which we receive the greatest amount of "reflected" sunlight.

7. Efforts must be made to locate other direct voice mediums who have the capabilities of those two very rare persons -- Emily French and Leslie Flint. There is evidence that a very few such unusual people may be alive today but they are said to shy away from any public exposure. However, if one or two such people would

agree to work quietly and confidentially in the research lab of Metascience Foundation or in any similarly qualified lab, development of successful equipment could be advanced by several years.

8. Research in this field is, in our opinion, not of a type that can be taken over at this time by one or more of our huge industrial-commercial corporate entities. The individual workers must possess a special background of in-depth knowledge of psychical, religious and occult lore and be totally dedicated to the goal of using the energies involved for only the advancement of the human race. In no sense can this research be organized or run by a committee. For now (that is, in the present embryonic stage) the work is primarily for the non-organization man -- the so-called odd-ball, the lone wolf. We are still in the inventive, the creative stage -- the stage where an Edison, a Bell, a Morse, or a Marconi is needed. The accomplishment of Metascience Foundation in bringing this development to its present stage -- admittedly crude -- is remarkable. The idea back of it all could never have made it through even the authorization-of-funds stage at IBM, GE, ITT, Telefunken, Phillips, ASEA or similar corporations!

The only viable role for these or other industrial giants or wealthy individuals, is to contribute funds to individual researchers who have already been working for years in this most unorthodox field in England, France, Sweden, Germany, Italy, Brazil and the USA. Such grants should be on a "no strings" basis just as funds are granted in the amount of millions of dollars for support of Public Broadcasting programs.

9. For purposes of perspective on Metascience Foundation's decade of research and development of SPIRICOM, this tabulation will be found useful:

SPIRICOM Prototype Development

(Listed chronologically and in frequency of vibrations in cycles per second)

Mark I	1971 - 1973	300,000,000 Hz
Mark II	1973 - 1977	1,200,000,000 Hz
Mark III) IV)	1977 and continuing	29,000,000 Hz
Mark V	1976 and continuing	10,250,000,000 Hz
Mark VI	Flame or Plasma Transducer (projected) approx.	100,000,000,000,000 Hz
Mark VII	Electrically Activated Quartz Transducer & Ultraviolet Light. (Projected) approx.	10,000,000,000,000,000 Hz
Mark VIII	Living Plants as Transducers (Projected)	(...?..)

The above tabulation makes a comparison only as relates to electromagnetic frequencies, except in the case of living plants.

We hasten to point out however that successful communication will also be dependent on interfacing our energies with such types of presently unidentified energies now existing on the various levels of consciousness. These are depicted in the large colored diagram "In Our Father's House are Many Mansions," and discussed in Chapter 9.

We are so accustomed to talking about a few millions or a few billions that we often lose sight of the magnitude of what we are talking about. The same is true when we use the "shorthand" of electronics and speak of kilo, mega and tera hertz - or even use the scientific shorthand to list frequencies in terms of figure 10 to some power.

We feel that the above table, reverting temporarily to "cycles per second" as a means of expression, gives a bit more perspective of the scope of the various Metascience prototypes.

Perspective is also given by the fact that probably 90% of the EVP researchers up to 1981 have been using frequencies in the region of 1,500,000 Hz, well below those listed for Marks I through VII.

MARK VI (Projected)

The Possible Use of Flame as a Massless Transducer

In the many years of contact with Dr. Swann and his team on the Mental and Causal level we learned that the energies of which the worlds of Spirit are composed can best be comprehended in terms of light. Even the signals generated by Marks I, II and V were discerned by our team in Spirit as pulsating shafts, spirals, circles or vortexes of light. As reported in the preceding chapter, they said that the energies which they were endeavoring to impinge on our signals should also be thought of as a form of "Light."

As we gave further study to the fundamental problem of creating a transducer which could serve to receive spirit energy signals and convert them to impulses that could be sensed by our earth-side equipment, we began to speculate about the possibility of using plasma in a flame.

The search for a truly massless transducer has been going on in the field of audio research since Alexander G. Bell invented the telephone. It was given new impetus with the advent of "high fidelity" sound reproduction and resulted in a few very interesting devices. The most unusual among them seem to be based on the work of Dr. Sigfried Klein in Germany who invented a device in the 1950's which he called IONOPHONE.

In 1966 the United Technologies Center in Huntsville, Alabama and the Shell Research Laboratories in England published news of their research with flames. In the lab at Huntsville they hooked up a power source, a tape recorder and an amplifier with an ordinary acetylene torch. "We were quite startled to hear the flame of the torch reproducing the sounds of the tape recorder -- and quickly made a couple of tests to be sure we were not imagining things," said Babcock, one of the scientists.

Since that time additional research has been done on the subject and it is possible to make a flame produce sound under a variety of conditions. Scientists are, however, quite honest in admitting that they still do not know why fire can be made to reproduce sound.

Even so, progress has been made. It is known that the flame serves as a multidirectional speaker. The sounds are emitted from the flame in all directions with equal force. Moreover, the flame seems to be able to reproduce sounds no matter how closely spaced they might be.

The gas within a plasma has an extremely low density, relative to the gas surrounding it. Thus, when cool gas is heated to the plasma stage, it expands in volume and imparts a pressure wave to the surrounding gas. The audio signal varies the volume of the plasma and produces the sound wave.

As of 1982 there is a substantial growth in the interest of using plasma to achieve 700 Hz to 100 KHz audio response. Such devices are being developed in Europe and in the USA.

In considering use of a flame in a device for communicating with persons living in the worlds of Spirit, we have not been thinking so much of the use of the flame as a loudspeaker. Rather we have speculated on the possibility that the spirit energies might be impinged on the flame and the reaction thereon detected and eventually fed into an oscilloscope, loud speaker or other device. One configuration to be considered for the very first investigation might be as shown here.

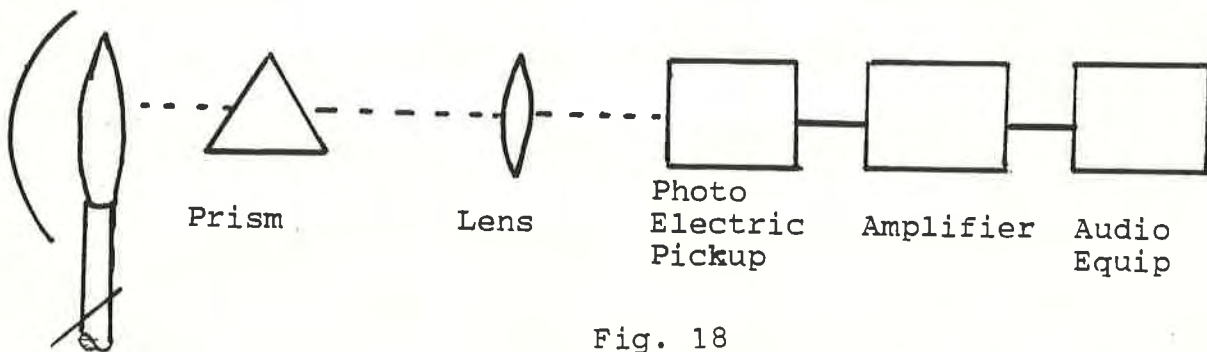

Fig. 18

Before concluding this greatly abbreviated introduction to the subject of flame, we rather jokingly mention what might have been the first recorded reference to it as a transducer! We quote from the third chapter of Exodus:

And the angel of the Lord appeared to Moses in a flame of fire out of the midst of a bush; and he looked and, behold, the bush burned with fire, and the bush was not consumed.

And Moses said, I will now turn aside, and see this great sight, why the bush is not burned up.

...And God called to him out of the midst of the bush and said, Here am I.....

And whether the speaker was God, an angel or some other renowned being, we can be sure that he was a personage of a higher level of consciousness than we have been able to contact with Mark IV!

MARK VII (Projected)

Electrically Activated Quartz Transducer Using Ultraviolet Light

Any serious student of esoteric and metaphysical writings knows that over the many centuries there were frequent references to Man as a light being. Moreover, any person who is presently a member of a spiritual development group is completely familiar with the knowledge that evolved souls on other planes of consciousness exist in their "Light Bodies." The New Testament references to the Nazarene being the "Light of the World" is perhaps more than just a poetic phrase, inasmuch as 2000 years have clearly shown that He was one of the most evolved individuals the world has known. Thus we have a growing realization that light and consciousness are in at least some aspects connected or even synonymous.

Now consider another item which bears on the possible relationship between light and consciousness. We refer to the work being done in the Metascience laboratory by Meek and Dapkey in analyzing photos collected from various parts of the world. Strange and unaccounted-for items are seen in the photographs. (Refer to our booklet THE MAGIC OF LIVING FOREVER.) The unusual portions of these photos appear as "light objects" of many shapes, sizes and types - and often in many startling color effects. Sometimes they consist of photos of persons known to have been dead for many years. None of the objects were visible to those present at the time the photographs were being taken.

In our extended conversation with Dr. Mueller (via SPIRICOM) and with other scientists in the world of Spirit (via telepathic channels) we have confirmed that they themselves are in fact composed of light at differing wavelengths. We have confirmed that most of the inhabitants of the Spirit world exist at wavelengths outside those which can be detected by normal human eyesight.

In the preface of ON THE EDGE OF THE ETHERIC, Arthur Findlay used the accompanying diagram as a frontispiece. In that book he reported that the spirits who communicated via direct voice through the Scottish medium John C. Sloan, stated that the etheric world begins in the area immediately above the narrow band of light waves visible to the human eye. In this simplified sketch of the electromagnetic spectrum, made in 1928, Findlay labels the area immediately above the visible waves as the "etheric world" (the area on the upper right of this spectrum diagram).

VISIBLE AND INVISIBLE VIBRATIONS

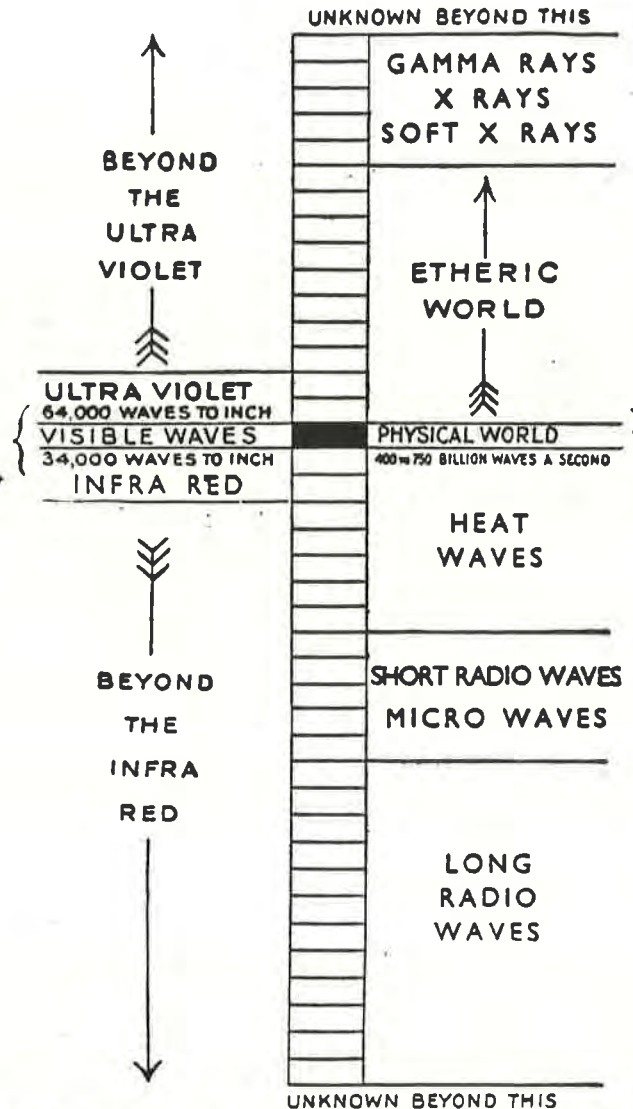

Fig. 19

The above chart makes clear how limited are our sense perceptions. Only the black portion represents the visible spectrum. This is all we sense of the innumerable etheric waves making up the Universe. The author has been told by his informants in the Etheric World that its vibrations just about touch those of the Physical World, and at times they can be detected by clairvoyance, by the seeing of etheric beings, called ghosts, and by psychic photography. Etheric waves, however, seem to be different from physical waves, as so far we have discovered no instrument to contact them.

It is of considerable interest that one of our high level communicators (Samarka, the highly evolved counterpart of our telepathic channel) told us in the session on March 15, 1975, "Dr. Norbert says that thought waves are just beyond the border of the ultraviolet light frequencies." In that period we did not know enough about these matters to ask, "Which border? The one near 400 nanometers or is it nearer 200 nanometers?" As of early 1982 we would speculate that it is somewhat nearer 400 than 200. It is an important point and further enlightenment must be sought.

If you will now turn to our Volume VI, THE MAGIC OF LIVING FOREVER, you will see what may well be one of the first color photos of an etheric being, captured under controlled conditions in the Metascience laboratory. (I refer to the larger of the two photos on page 10.)

While still looking at this photograph, note that there are two streams of light projecting to the right of the upper light-colored area. This might be the first time the energy streams from the right and left hemispheres of a "mind" have been captured on film.

We now have reason to believe that Dr. Walter Russell knew what he was talking about in 1926 when, after 39 days in an altered state of consciousness, he said, "Mind is light...Mind thinks in two opposed lights, simultaneously projected from their centering white light source -- and sequentially repeated in cycles." (Reported in THE SECRET OF LIGHT by Walter Russell.)

In the photo taken in the Metascience lab (page 10 of THE MAGIC OF LIVING FOREVER we have the four conditions mentioned above: centering white light source; the two opposed lights; the lights are projected; and they are sequentially repeated. (The negative from which this book reproduction was cropped is larger and of better color fidelity. It clearly shows the repetition in cycles.)

Now back to the problem of creating a version of SPIRICOM that can tap the higher levels of consciousness! The most crucial problem in the design of any such communication system is to provide some point in the apparatus where the energy from the spirit person (his or her thoughts) can impinge on some signal that we generate with our equipment. This is one tough problem! Trying to get the thoughts of a spirit person to "impinge" or "interface" with our signal, even if we use MHz, GHz or THz frequencies, is like trying to mix distilled water with axle grease.

But -- and here we come to the hypothesis that Meek has created for Mark VII -- if mind and thought are "light" as Russell said in 1926; if Findlay was right in 1928 when he said the etheric world starts with the ultraviolet portion of the electromagnetic spectrum; and if the mind projects two parallel streams of light as shown in Meek's photo of 1979 -- why not build a transducer which allows those two streams of light to modulate a beam of ultraviolet light and give us an instrumental readout via strip chart recorder, loud speaker, oscilloscope or a computer printout?

We offer these thoughts free to all of our fellow SPIRICOM researchers around the world. (The term EVP has served its period of usefulness. Now it can be replaced with the far more meaningful term SPIRICOM, which we gladly offer for generic use.) We hope many researchers will join us in a friendly race to see who will be the first to successfully build and operate a SPIRICOM system utilizing ultraviolet light and a spirit energy transducer. Let us get on with the job at the earliest possible moment!

MARK VIII (Projected)

Living Plants as Possible Transducers

In our search for systems which can carry on two-way conversations between us and persons on higher levels of consciousness we have assumed such persons in some way might be able to react with various electronic components. We have been exploring radios, signal generators, tape recorders, oscilloscopes and other devices involving electromagnetic and electrostatic fields.

We have had some initial successes with these approaches - with Mark IV in particular. However we feel we should look beyond these more obvious devices and energies, now that we have learned more about the crucial importance of the spirit energies.

The one thing we do know about spirit energies is that they are living energies - energies of beings or persons who are pulsating with life and consciousness. There is much evidence that Mark IV functions successfully in its present form only when we have present in the lab some very special and as yet unidentified energy from a person alive in the flesh. So in a very real sense we seem to have an indication that perhaps we should explore the possibility of finding some form of life other than a human being to serve as a transducer between our electronic equipment and spirit energies at the mental/causal level.

There are numerous examples of situations in which a dog or cat will suddenly show alarm when detecting the presence of something which is unseen with the human eye. When a good clairvoyant is present on such an occasion he or she can sometimes "see" the same spirit being which has been detected by the animal.

.It is unlikely that the animal could be "wired" in any way to make it serve as a transducer for information-packed messages from a spirit person even if it detected same. And usually the animal responds instinctively in such a situation with a fear of the unknown - often with an attempt to protect his master from anything new or strange.

Living plants on the other hand are readily available, inexpensive -- and expendable! Drs. Burr and Northrop of Yale University in 1935 used a vacuum tube voltmeter to show that the L-field of a tree or plant could be used to measure cell potential and the voltage variations in same. Later Baxter, Lawrence, Vogel, Sauvin and others developed techniques to measure the potential between two electrodes on the leaves of plants. Presently both systems can record only the presence of energy. Whether these are electrical, spirit, emotional, life or other types of energy is not clearly understood at this time.

An initial experiment might be to find music or audio tone combinations that the plant feels comfortable with. (See THE SECRET LIFE OF PLANTS by Tompkins and Bird) Then apply these audio tones to the plant with a pickup on the leaves or leaf stem.

Fig. 20

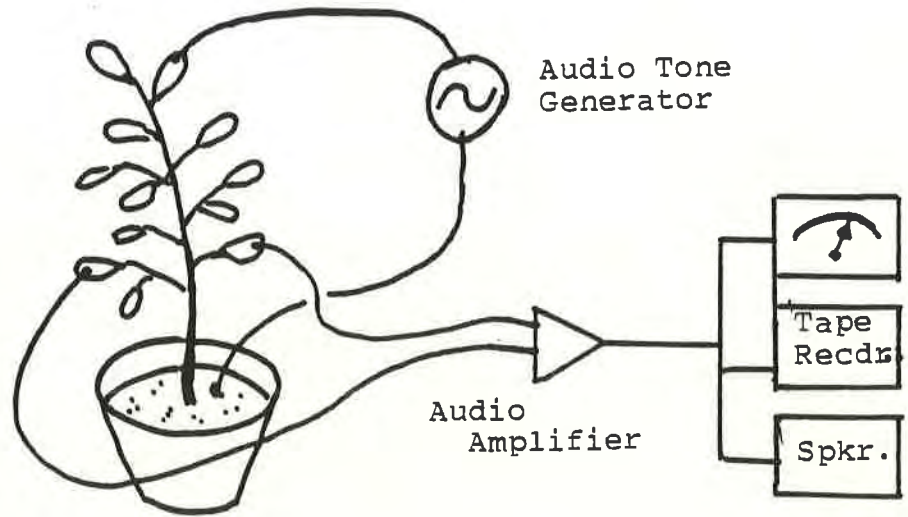

Using an audio signal would reduce the problems of electrode potential which becomes a source of noise. Also, we find in our experiments with Mark IV, the audible tone makes it easier to produce words.

A study of the rapidly expanding literature on the interaction between plants and people may reveal other possible avenues for using a living plant as an interface between the intended spirit communicator's energies and whatever electronic system might be assembled.

..... and what follows Mark VIII?

Will it be -

Fig. 21

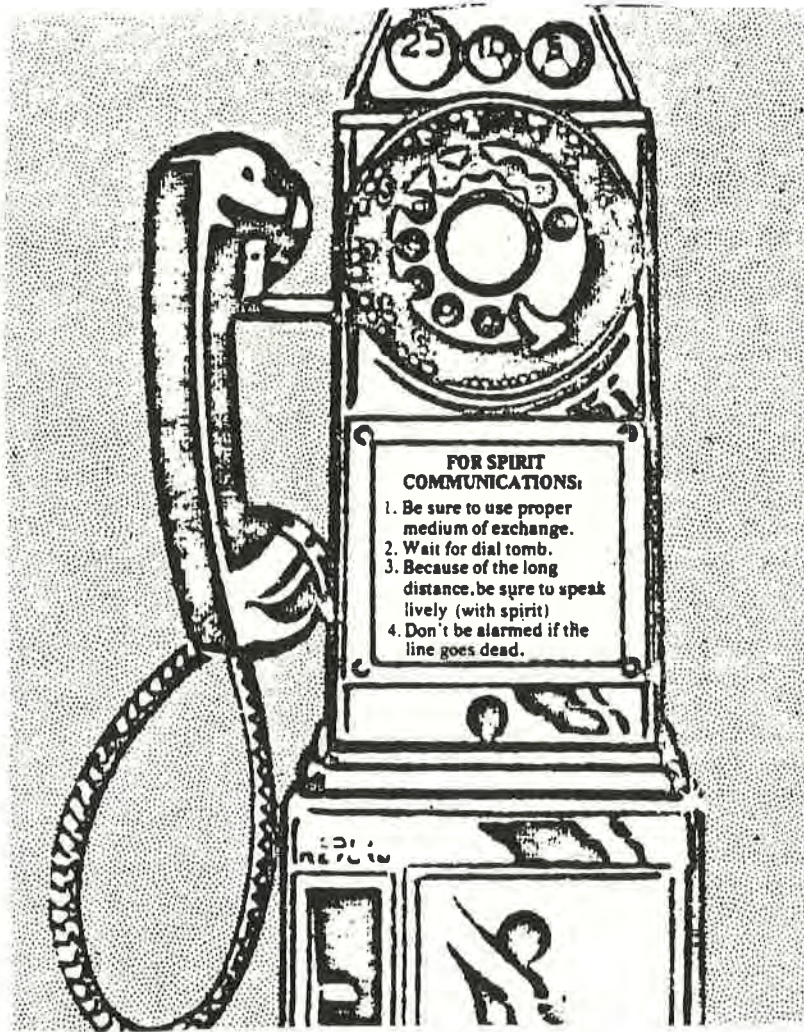

MARK ????????

Yes, a little humor is quite necessary when we are working on a project as deadly serious as SPIRICOM.

Partly to have a little fun, but also to help us "focus" our minds on the many-pronged assault on SPIRICOM, we occasionally glance at the "art work" on the following page.....

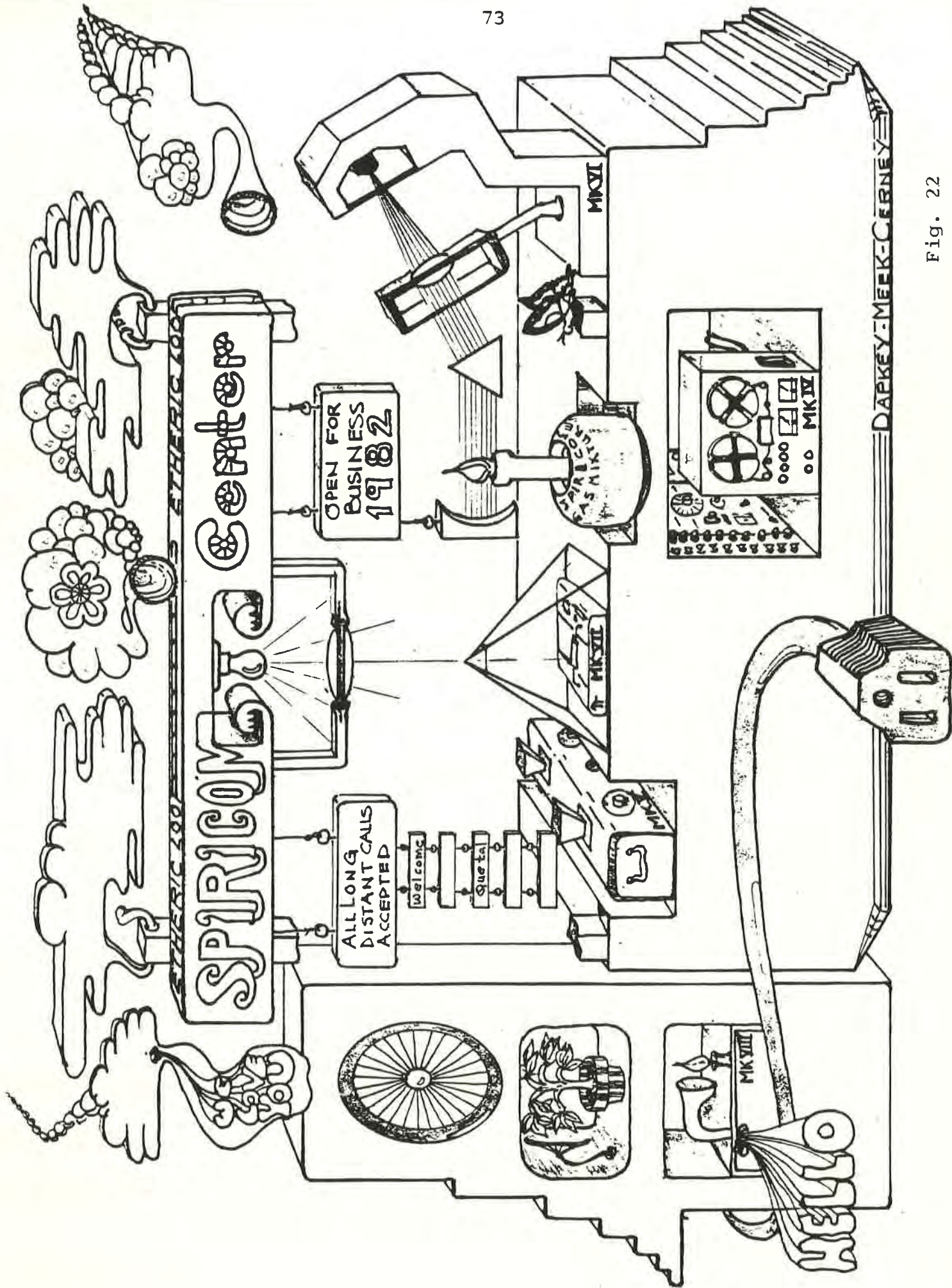

Fig. 22

RESULTS TO DATE

Charles Kettering, the General Motors genius of almost half a century ago, observed, "Nature does not give up her secrets easily." In solving the mysteries of spirit communication, we must pry from nature many bits of information that are far more tightly held than those she surrendered to designers of components for motor cars!

During the past decade of Metascience's intensive effort, few indeed have been the secrets which have been penetrated. And when we consider the number and nature of the secrets for which answers must still be found, it requires a strong heart and dogged perseverance to push ahead day after day and year after year.

But, fortunately, this important fact rings out loud and clear:

In 1981, meaningful two-way normal-voice conversations were carried on via SPIRICOM Mark IV over a period of many months with an American scientist who has been "dead" since suffering a coronary failure in 1967.

This fact is now inscribed forever on the history books. Perhaps nothing in the last 2,000 years has provided more solid scientific evidence that Man has what the Apostle Paul called a "spiritual body" and that that body survives the death of the physical body.

And we have been fortunate in chalking up some additional accomplishments, the full value of which will be more apparent in the decades ahead:

1. Two-way voice communications, similar to that mentioned above, were carried on in a limited way with three other "deceased" individuals who stated that they passed over in 1820, 1830 and 1972. These provided at least the first stage of the replication that is so properly a part of the scientific method.
2. We have accumulated much information which will be of help in the coming decade to hundreds of researchers. This information will save time and money and lend encouragement. (As indicated on page 6, all of our findings are made available to fellow researchers free of any patents, copyrights or trademarks.)
3. By the use of gifted sensitives or mediums who have the ability to act as telepathic channels, we have had the rare privilege of more than 200 hours of normal conversation with many persons now very much alive in the higher realms of life.
4. These conversations have enabled us to draw a blueprint of "the many mansions" about which Jesus spoke -- and describe

in some detail who lives in which mansion, and what life is like in the various mansions. (See AFTER WE DIE, WHAT THEN?, AS WE SEE IT FROM HERE and THE MAGIC OF LIVING FOREVER.)

5. We have found that the more enlightened souls living in these higher realms are awaiting, even more anxiously than we are, the successful completion of an instrumental communication system. They feel that only when the perspective they have, is gained by Man on earth will he cease and desist from the many completely stupid, wasteful, destructive and non-productive acts which now threaten him with extinction.

6. We have found that there is a scientific basis for the central core teachings of all of the world's great religions: Protestant, Jewish, Catholic, Shintoist, Buddhist, Muslim, Coptic, Hindu, etc. When, in the decades ahead, such instrumental communication is perfected to the point that regular two-way communication takes place with the mental-causal plane, it will be possible to strip away much baseless dogma and creed. This will eventually make possible a true marriage of religion and science.

7. Because of our research into the basic nature of Man, we have developed a far better understanding of illness, disease, and good health. When, through the now rapidly emerging practice of holistic medicine, these insights become known to the average man, our levels of health will be higher, life span will increase and much needless poor health will be avoided. (See HEALERS & THE HEALING PROCESS.)

8. We have received from our scientist communicator in another world, a theory of -- and an electronic circuit for -- an instrument for use in the treatment of persons suffering from painful arthritic joints. The preliminary results from our small-scale field trials of our prototype model indicate that the idea may have enough merit to warrant greatly expanded field testing.

9. We have not been successful to date in efforts to obtain images on the video screen of any of our deceased communicators. However, we have reason to think that within two decades it will be possible to obtain images of persons now existing in what we call lower and middle astral planes.

10. We have learned that before perfecting SPIRICOM to the point that it can be a useful day-to-day working reality, Man must learn far more about several types of subtle energy and their forces or systems which lie completely outside what is now recognized by science as the four basic forces of nature. Thought must be recognized as an energy, and means of observing, detecting, measuring and possibly photographing it, must be developed. The same applies to the energy forces involved in all psychic activity.

Much of the pioneering in this field will have to be done by non-scientists. This is because the work must be pursued with totally open and enquiring minds and by researchers who are themselves psychically sensitive.

11. During our three years of contacts with Dr. Mueller (clairvoyantly, clairaudiently and via SPIRICOM) we have accumulated many notebooks filled with data, and recording tapes and transcripts thereof. This material is being made available in a book which should warrant translation into many languages.

Each of the advances listed above is important, but one stands out and deserves repeating:

Meaningful two-way audio communication has, in fact, been carried on with an American scientist who has been "dead" since 1967.

And as we said on page 9, "With these preliminary thoughts on the record, we will spend no time refuting any accusations of fraud, hoax or misrepresentation of results. We are quite content to leave all such matters to the unfolding of history in the 21st century."

The above tabulation indicates the direction of our planning for the next two years. We will definitely continue with intensive research on Mark IV and Mark V but also initiate new research projects on Mark VI, Mark VII and Mark VIII. We certainly encourage other researchers to choose any of these five areas for their own efforts.

In order to provide some thought stimulation to other researchers around the world, we now present some of our VERY PRELIMINARY thinking on the last three prototypes mentioned.

POTENTIAL BENEFITS
(of Making SPIRICOM a Working Reality)

Individuals connected with Metascience Foundation have, over the past ten years, made tremendous effort and great personal sacrifice of time and money in their attempts to create a device to allow communication between men on earth and men in higher levels of consciousness. Why? What has been their motivation?

It would be easy enough to answer, "The benefits to Man would be very considerable. Here is a list of the more important ones." But such a listing without some additional information would not convey the importance of some of the items. So before we spell out the benefits as we see them, we would like to share with you the thoughts in Meek's mind when the list of benefits was formalized. A memo from him to his associates on July 4, 1976 reads in part:

Two hundred years ago 56 courageous and far-seeing men devised and signed a "Declaration of Independence." They put their reliance in Divine Providence and pledged to each other their lives, their fortunes and their honor. These were men of means and education. They paid dearly for their action. Five were tortured and killed as traitors. Nine fought and died in the war which followed. Many lost all of their belongings and they and their families were forced to move frequently. Many died in poverty.

The nation-state which grew and flourished as a result of the vision and spiritual insight of these men became the light of the world. No other nation in the world's history has contributed as much to the development of human dignity, and had such a beneficial impact on other nation-states around the world.

These two centuries have seen the birth and growth of many fields of science. The ways in which these sciences have changed and are changing the material life of Man stagger the imagination. Certainly in the main these advances in Man's material well-being are beneficial.

It is now plain for everyone to see that, unfortunately, mankind's advances in the material world have far outstripped his rate of growth in wisdom and spiritual understand. After two devastating world wars there are many signs that we face the prospect of a third - and final - world war. The advance in man's capability for mass extermination has grown exponentially, precisely as outlined in an analysis which I wrote in London on July 4, 1943 and distributed to my close friends as a Christmas and New Years greeting in December 1943. My comments and the accompanying political cartoons which I devised, set forth the need for recognizing Man's INTER-dependence.

It is with profound regret that these last 38 years have done nothing but confirm that analysis. Every "Advanced" and "emerging"

nation in the world today is spending vast sums in an armament race to outdo its neighbors. At least ten nations have acquired the capability to wage nuclear warfare - and very few indeed of these nations have acquired the restraint which could make them refrain from using these weapons of mass destruction. Only a small proportion of the people alive today have learned the eternal truth of the statement that "Those who choose to live by the sword will die by the sword."

Now, as we enter the last quarter of this century and start on the third century of our nation's history, is there nothing that can be done to arrest this headlong flight to oblivion? Is man totally incapable of any action which can redress the evolutionary imbalance between his materialistic and his spiritual development? At this crucial time in the life of our nation and all nations are there no men of vision who can see the path which can lead to a brighter future? Dare we despair and cast our lot with those who advised Job to "Curse the Lord and die"? Is there no way that man can be made aware of his INTERdependence - made aware that by all men working together, life on this planet can become a veritable Garden of Eden?

These questions have been in the back of my own mind ever since that Independence Day in London 38 years ago. Until recently I have despaired that anyone would come forth with a vision which was equal to the needs at this point in man's evolution. In fact, it is doubtful that even a second coming of the Nazarene would correct Man's materialistic-spiritualistic imbalance. But slowly in the six years since I started my own full-time research into the nature of Man, I have begun to see a glimmer of light at the end of the long, dark, often frightening and discouraging tunnel. As I have met and observed in most of the civilized countries of the world, courageous and forward-thinking people in the fields of medicine, psychiatry and many branches of science; and as I have read extensively in the fields of religion, mysticism, the occult and the fields of psychic and parapsychological research, I have become acquainted with dimensions of Man of which much of our present materialistic world is unaware.

Surprisingly these new dimensions suggest a course of action which is so revolutionary and has such promise of success that in just one century it could have as profound an effect on mankind as did the evolutionary step when life moved from the sea to the land.

Very briefly, here is the outline of what is behind the above presumptuous and obviously preposterous statement.

There is now absolutely no doubt that Man is a multi-dimensional being who not only lives and moves and has his being in our commonly accepted space-time continuum but who simultaneously lives and moves and has his being in another space-time continuum of which modern science is only slightly aware. His physical body operates in our well-known 3-dimensional space-time system. His

levels of mind and spirit are in every way just as "real" as his physical body (perhaps more so!) but operate in a totally different space-time continuum.

And what is of history-making significance, his mind and spirit disentangle themselves from the electro-biochemical mechanism that is his physical body and continue life as a distinct personality as soon as they pass through the door which man calls "death".

Modern science is unaware of this other space-time universe which interpenetrates our physical 3-dimensional space-time universe. It is totally ignorant of the fact that the minds and spirits of persons considered dead are very much alive and well. Moreover, some of these intelligences have access to wisdom which has been accumulated by all of the individuals who ever lived on the earth-plane - the wisdom of the so-called collective unconscious.

(In this effort to put down on paper the overall concept of what I know to be factual, I am not writing a paper to be read and accepted by my materialistic peers. But, like the 56 who signed the aforementioned "Declaration," I am quite willing to pledge - and in fact already have pledged - my life, what I have of worldly goods, and my honor, to try to carry through the activities herein disclosed. Hence, I do not today waste time on bibliographical references and supporting documents. In fact, such will not be needed if we can carry to a successful conclusion research now underway. The results would speak for themselves.)

We have often speculated on the ways by which the perfection of such equipment would change Man's thoughts and actions and the course of evolution of homo sapiens in the centuries ahead. However, we never seemed to be able to spare time from our precious hours in the lab to discuss in depth or to prepare a summary of these speculations. Therefore I have concluded that in the spirit of this day, which is an obvious milestone in the history of our nation and the world at large, I would take the hours necessary to draft a list of the potential benefits for Man.

[The list which then followed in the letter was essentially as shown here:]

1. For the first time in Man's history it could be proven that . Death is merely a door to a continuing life. This will permit Man to understand that his mind and spirit are only temporarily occupying his electro-biochemical body.
2. It will be shown that individuality and consciousness (personality) continue to exist and function in a disease and pain-free environment and with unlimited opportunity for continuing mental and spiritual development.
3. It will remove forever the needless and destructive fear of death and eliminate the cause of mourning and sorrow at the passing of a loved one. Thus we will eliminate the taboo which our culture has imposed on the whole subject of death.

4. It will make obsolete those portions of religious dogma and creed which over so many centuries have needlessly ruined countless lives by the imposition of burdens of fear and guilt.
5. It will begin to show that at last Man has a scientific basis for understanding the common spiritual teachings of all of the world's great religions. It will bring about changes in science and religion to the enhancement of both. Thus it will begin to lay a basis for a lasting marriage between the two.
6. Each person will at last learn that it is his own mind and spirit - through his thoughts and emotions - which determine to a very great degree whether he will experience sickness, or enjoy vibrant physical and mental health. Then he will know that he should at all times be the complete master of his body.
7. The preceding item could, within only one or two decades, completely change the whole nature of personal and public health care with savings in the USA alone of billions of dollars annually in medical, drug, nursing and hospital care.
8. By utilizing the highly refined diagnostic abilities of medical specialists on the other planes of existence we would make a quantum leap beyond the diagnostic capabilities of our most elaborately equipped and expertly staffed diagnostic clinics. (We have already been assured of this collaboration.)
9. It will permit the people of each nation to converse with their own previous national leaders and learn how different is the present perspective of those leaders on the subjects of war, racial and religious strife, armament expenditure, etc. One obvious benefit would be to "buy time" for a few years until human consciousness evolved enough to forestall what would otherwise be the final world war.
10. It will help our educators devise procedures by which the masses would gradually be given access to levels of knowledge which would greatly accelerate their mental and spiritual development.

This would result in a total redesign of our educational system. It would allow tapping the accumulated wisdom of the ages. (Just consider the ramifications of having lectures given in the new universities by Plato and Socrates with all of the additional knowledge they have gained in the passing centuries of exposure to still higher intelligences.)

11. By showing that Man is an inhabitant of the apparently limitless cosmos - far from the soul-less bar-pushing rat and corn-

pecking pigeon our behavioral psychologists proclaim - he can begin to act in ways that will permit him and his descendants to become respected participants in the operation of the cosmos.

And the foregoing is only a limited outline of what Man could accomplish in just the next century - a mere instant in his long upward climb.

Stop for a moment and ask yourself this question, "Of all the many activities in which individual persons and organizations are involved today all over the world, how many can I list which have as much potential as does SPIRICOM research for preserving and advancing civilization?"

-----0-----0-----

Now six years after Meek prepared the above list of potential benefits, not even one item has become obsolete or in the need of major revision! And the passing of time has shown even more clearly the acceleration of our materialistic civilization toward disaster.

Sadly we must admit our failure to achieve the objective in item 10: delaying the onset of the final world war. As of early 1982, we have already witnessed the opening skirmishes, so our objective may have gone by default. Time may have run out.

But if Man is to survive the impending cataclysmic social, economic and political changes that are rushing down upon him, the potential benefits of SPIRICOM are enough to stimulate researchers to perfect it at the earliest possible date.

THE VERY REAL DANGERS
(of Operating SPIRICOM-type equipment)

1. Dangers which could be encountered by individual researchers

Under no circumstances do we want to encourage any enthusiastic reader or potential researcher to start out in this field without the information in the next few paragraphs.

As was pointed out earlier, science now knows that everything in the cosmos is one or more forms of energy in motion. Some energy is beneficial to Man and some is harmful. X-rays for example, in small and carefully controlled amounts, can be of great help to Man, but in too great a concentration can destroy tissue, entire organs and even the whole body. Ultra-violet light is highly beneficial to Man and plants, but certain wavelengths of UV can kill not only bacteria, but also plants and even people. (In 1978 in our laboratory in Ft. Myers, Florida, we were experimenting photographically with different wavelengths of UV light. After an exposure of only a few minutes at one of the wavelengths we were using, all of our lovely 3-year-old ivy plants and philodendron were killed and the green leaves became as black as carbon.)

On the 11" x 17" diagram, "In Our Father's House There are Many Mansions," please note near the left margin the vertical arrow which reads, "MATTER (Energy) at progressively HIGHER rates of vibration or frequencies." In this diagram the energies which make up the minerals and water of the earth are at the bottom, (the lowest vibrational level). Man and all other living creatures and life forms on the surface of the earth are composed of bodies which contain essentially the same minerals and water, but in addition, they have consciousness which represents a higher rate of vibration.

The lowest astral planes shown in the above-mentioned diagram contain persons who have shed their mineral and water bodies and exist as their individual consciousness. Hence they are not suddenly all-wise. They know absolutely nothing of the "worlds" that exist above them. They, for the most part, are truly "lost" and many do not even know that they are dead! Many of them are desperate to get back into their old physical body. Some of the poor souls are filled with the strongest of physical lusts and desires for alcohol or other drugs. They may make a serious effort to continue their indulgence by finding some person whose energy field is enough like theirs that they can be merged. This is the basis for obsession.

Although present-day psychiatry does not yet recognize it, we feel reasonably certain that at least 25% of the patients in our mental asylums are, in part, the victims of such unwanted intrusion into their individual consciousness by entities on the lowest astral planes.

[We do not condemn psychiatry for this lack of understanding. It is only in the last few years that Man has gained the understanding that the mind is non-physical, that it is, in fact, an energy field, and that it can, and in some cases does, occupy a body other than that for which it was intended. Fortunately there is now a newly formed branch of the psychiatric field known as Metapsychiatry

which is increasingly making use of the latest scientific findings in this area. And it is gratifying that in 1980 the American Psychiatric Association added "multiple personality" to its diagnostic and statistical manual of mental disorders!

When any person starts to build equipment designed to "talk to the spirits" it behooves him to carefully bypass all the persons now very much alive in the lowest astral planes. (Incidentally, this area is also populated with some rather frightening forms of life which do not belong to the human line of evolution.)

In fact, it is not enough to just tune out the lowest astral planes. There is another hazard to be encountered a little higher up. There is a layer of spirits who are not really intending to be harmful and they are not likely to lock into your aura. But they are out to have some fun -- they are more like pranksters. Should you contact them, they may pretend to be someone they are not. They may, as we say, "take you for a ride ." They may appear much more knowledgeable than they are.

It is because of these "communication hazards" that mediumship got such a bad name 2,000 years ago. At the time of the events in the New Testament, mediumship was very common. Its dangers were also well known, because it was a rare medium indeed who could tap the wisdom of the highest astral planes. Anyone who could tap that of the mental-causal or the celestial planes went down in history as a prophet, sage or seer! The writers of the New Testament cautioned their small flocks to "Beware!" and to "Test" all spirits with whom contact was made, to make certain that the communicators were good, friendly, God-fearing spirits.

How does an EVP or SPIRICOM researcher make certain that he does not attract a cloud of undesirable spirit persons? There are two precautions:

First, never work in this field unless you are in excellent physical health, free of serious mental or emotional stresses and strains, and have an optimistic and joyful attitude about your life and toward all with whom you come in contact. If you cannot honestly say that you fit this physical, mental and emotional profile -- then find some other outlet for your inquiring mind!

The second point requires a bit of background. You daily use your radio and/or TV. When you want to switch from one station to another, you turn a channel or station control knob. By so doing, you turn from one wavelength or frequency to another -- either higher or lower. A SPIRICOM set operates the same way. But the "good" SPIRICOM programs come in only on the higher wavelengths or frequencies. Hence you should try to use a set which will get up beyond the stations which have only the "bad" programs.

Unfortunately this is easier said than done. Most of the EVP research has been done in kilohertz wavelengths. It is the consensus of the researchers at Metascience Foundation that you will

never reach the desired intelligence levels at these wavelengths. Even at a far higher level -- 29.5 Megahertz -- we have on occasion, tuned in to some very uncouth characters using language which was not fit for print.

In general we feel that, in the years ahead, researchers should constantly strive to establish systems which will reach ever higher frequencies. Our projections for Mark VI and Mark VII show how seriously we ourselves take this bit of advice.

If you as a researcher have followed the above precautions, you may very well reach individuals who are highly evolved in the best spiritual sense. They are interested -- deeply and solely -- in helping Man on earth to grow up out of the quagmire of hate, jealousy, murder and materialism which he has fashioned for himself. If you want to narrow the gap from where you individually stand in your own spiritual development, and the level of spiritual growth which your prospective communicators possess, you will find it helpful to include one or two short periods of meditation and prayer in your daily schedule.

Does this prescription work? Yes, speaking from the personal experiences of our associates during the past ten years. Are the dangers real? Yes. Among the researchers in this field who failed to follow the above warnings are at least one known suicide and two cases of possession. Either suicide or possession is a high price to pay for disregarding admonitions that have their basis in 2,000 years of history.*

2. Dangers which Mankind faces if SPIRICOM is not used wisely

Since his beginnings, Man has been faced with the fact that individually and collectively he has the power to act for good or evil. As his knowledge of the energetic nature of the cosmos has expanded, Man has found that every energy so far identified -- from sexual energy to atomic energy -- can be used for his benefit or for his downfall. He will find that the energies involved in SPIRICOM are also of a nature that can be used to help him grow mentally and spiritually and become more God-like (that is more like the beings on the higher planes) or they can be focused on trivia which will make it even harder for him to grow out of the present deplorable mess in which Western civilization's social, economic and political actions are tending toward disintegration.

When SPIRICOM instrumentation is further perfected, it will, in the very nature of product development, be more simplified and available at lower and lower cost. (Already we discern the

*For the spiritually oriented, we report some advice given by high level spirit communicators: If SPIRICOM researchers adhere to the following procedure they will not suffer possession by negative forces. First thing in the morning say, "I will wear the protective cloak of the Christ light until I retire tonight." On retiring make a similar decree for the night hours. (Note: The Christ light is said to have overshadowed and inspired Jesus of Nazareth continually during the last three years of his earth life.)

possibility of making equipment to do the work of Mark IV, for example, in the form of a relatively inexpensive, compact, hand-held instrument.) Will such equipment be used to the maximum benefit of people -- both here and in the hereafter?

To the extent that it will reduce the sense of loss and grief at the passing of a loved one, it will be of great value. To the extent that it helps people learn that what we have called "death" is in fact, "birth" into another and potentially more glorious life, it will also be a great blessing. To the extent that it is used for the purpose of convincing a large portion of the 4,000,000,000 persons now on earth that they should live this life in ways that will assure the best conditions for their next life, it could be a tremendous factor in the upward evolution of Man.

But, sad to say, there is another side to the coin if contact is with only the lower planes. Consider these two omens of why widespread use of SPERICOM may not suddenly make Man into a new and noble creature.

First consider the parallel to what has happened in the last 100 years in the case of those persons who became deeply interested in all forms of psychic phenomena and concentrated in groups to develop their members into good mediums. The mediums brought through many messages which gave seeming evidence of survival. Such messages brought great comfort to many of the sitters. A few of the messages conveyed great spiritual truths and tried to show the wisdom of inculcating such truths into the daily lives of the sitters. A new religion called Spiritualism took roots in England, the USA and many other countries. A variant called Spiritism took roots and grew in France, Brazil and other countries. There were many who thought that this new religion would sweep the world. It has not done so. Why?

The answer has been provided during the last few years from Spiritualists now living on the higher planes. From their higher perspective (and speaking through the remarkable direct-voice mediumship of Leslie Flint) Sir William Crookes, Sir Oliver Lodge, Sir William Barrett, Emma Harding Britten, Ellen Terry and Sir Arthur Conan Doyle have said time and again, with great sadness, "Spiritualism has lost its spirituality! It has concerned itself with trivia."

They refer to the fact that Spiritualism (unlike Spiritism in Brazil) still concentrates on platform clairvoyance and mediumship which is in contact with only the lower astral planes. The messages brought through are primarily of a personal greeting type and very seldom contain any spiritually-oriented teachings from the higher levels of wisdom.

If SPERICOM is used in the decades ahead primarily to contact loved ones who have recently passed to the lower planes, it will have fallen into the same trap of being concerned only with trivia. Those living on the lower planes are basically no more evolved and enlightened than they were when they passed over. In the main, they did not produce a viable civilization when they were running the show here on the surface of the earth!

Only if Man is inventive enough to perfect forms of SPIRICOM which can communicate with the higher planes, can he tap the desired level of wisdom and spiritual enlightenment. And only if he then has the wisdom to use the devices for tapping that wisdom and enlightenment can he create heaven on earth. Will SPIRICOM users concern themselves only with trivia, or with the wisdom that could lead Man into the long-promised "golden age"?

And now let us look at the second reason why we should not expect that SPIRICOM will necessarily achieve the goal of making Man into a new and better creature. Let us take a strictly objective view of what has happened to the rosy-hued dreams of the miracles predicted to follow perfection of TV, motion pictures and radio broadcasting.

The following clipping was saved about 1975 from an electronics magazine (author unknown) because of its pertinence to the situation that would exist when someday we, or others, succeeded in developing SPIRICOM.

We should recognize that new technology readily evokes rosy expectations. Possible blessings are more easily glimpsed than problems, and are more gratifying to contemplate. As we have seen, visions of the wired world have been with us ever since the invention of the telephone. As early as 1882, an artist pictured a woman shopping via television, and another taking a course via television. In the early 1900s, the motion picture was expected to have many of the same effects predicted for telecommunications—wide dispersal of knowledge, equalization of opportunity, strengthening of democracy and of international understanding. Broadcasting, at the very hour of its birth, was expected to have similar effects. The first issue of *Radio Broadcast*, launched early in 1922, predicted that

... elicit a new national loyalty and produce a more contented citizenry. ...

... the government will be a living thing to its citizens instead of an abstract and unseen force. ...
... at last we may have covenants literally openly arrived at. ...

... elected representatives will not be able to evade their responsibility to those constituents who put them in office. ...

... the people's University of the Air will have a greater student body than all the rest of our universities put together. ...

That same year a former Secretary of the Navy, Josephus Daniels, joined in the sanguine predictions: "Nobody now fears that a Japanese fleet could deal an unexpected blow on our Pacific possessions. ... Radio makes surprises impossible." Magazine articles of the day featured such titles as "How Radio is Remaking the World" and "Radio, the Modern Peace Dove" and "Ether Waves vs. Crime Waves."

Can anyone deny that Man has failed to reap all of the early expectations for these remarkable technical developments? Can he deny that the increasing flood of pornographic movies and video cassettes may add to the rapid destruction of family life which has been the backbone of our civilization? Can he deny that there is any relationship between our spiraling crime rate and the exposure of our children to 15 years of murder, rape and other crime on our TV and movie screens?

Will Man similarly pervert the use of SPIRICOM? Any serious student of human nature is compelled to answer "yes."

However, there is one factor present in 1982 that did not exist while the commercialization of radio, movies and TV was occurring. Our communicators from the higher realms of Spirit have the ability to look, in a dispassioned way, at miniscule Man in his many senseless pursuits on the surface of the earth. They

have the wisdom which comes from their knowledge of the workings of the cosmos. They look at this small planet and are able to foresee the catastrophe which is soon to engulf our present civilization. Their precognitive statements are now coming into print in many nations. They predict that Man has passed the point-of-no-return and that our economy, our life styles, our political systems and our belief systems will undergo changes far beyond the scope which most persons can conceive.

In the summer of 1979 the Metascience Foundation publication COLLAPSE & COMEBACK presented Riley Hansard Crabb's highly informative study of the zodiacal and planetary cycles. One of Mr. Crabb's most useful diagrams is reproduced herewith. Notice the pivotal time in which we are living.

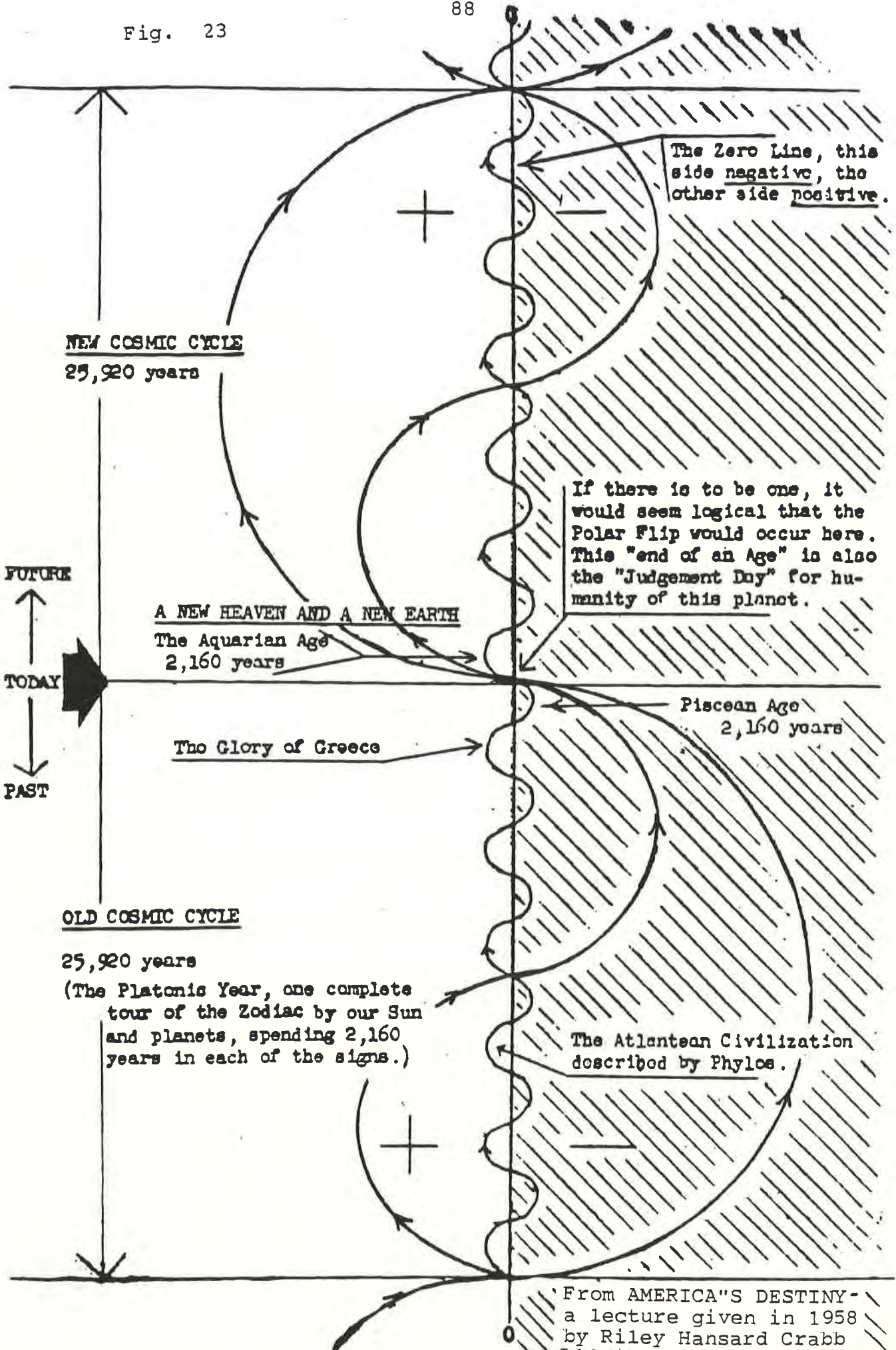

NEW COSMIC CYCLE
25,920 years

FUTURE
↑
TODAY
↓
PAST

A NEW HEAVEN AND A NEW EARTH
The Aquarian Age
2,160 years

The Glory of Greece

The Zero Line, this side negative, the other side positive.

If there is to be one, it would seem logical that the Polar Flip would occur here. This "end of an Age" is also the "Judgement Day" for humanity of this planet.

Piscean Age
2,160 years

OLD COSMIC CYCLE
25,920 years

(The Platonic Year, one complete tour of the Zodiac by our Sun and planets, spending 2,160 years in each of the signs.)

The Atlantean Civilization described by Phyles.

The far-reaching implications of the cosmic forces depicted in Crabb's diagram evoke serious questions in our minds -- as do the predictions from higher planes regarding impending cataclysmic changes:

Could it be that God, the powers above, the good guys upstairs, people on planes 6 and 7 of the "Many Mansions" chart -- whoever runs the show -- have for 70 years intentionally slowed and frustrated efforts of brilliant inventors such as Marconi, Tesla and Edison to create a SPIRICOM?

Could it be that in their infinite wisdom the higher beings decided to prevent the negative uses of SPIRICOM by not allowing its perfection until Man is so desperate, so frustrated, so cast down, that he will use it constructively to reach up to the higher planes, join forces with the God each of us carries within, and together build a new heaven and a new earth?

Yes, SPIRICOM obviously has dangers for materialistic Man. But it may also be the greatest single force for helping to erect the new heaven and to people the new earth which will follow the cataclysmic changes which we will all be a party to in this present decade -- and which will even begin to hit us hard in 1982 and 1983.

With the above closoing thoughts, the reader has a better perspective for considering the:

Objectives of METASCIENCE FOUNDATION

To provide a scientific basis for knowing:

- That life is *eternal*,
- That *each* person is a son or daughter of God, the Father, the Universal Mind, the Creator of all that exists,
- That the life of *each* person is of infinite importance and has specific purpose and ultimate meaning, and
- That *limitless love* of neighbor and self leads to inner peace, happiness and good health.

We believe Man can achieve this profound level of understanding by directly contacting the accumulated wisdom of the ages currently available on the Mental, and Causal Planes. It is our conviction that the most reliable access to this information can be provided by perfecting a *dependable two-way electromagnetic - etheric communication system*.

This would at last make possible a workable and rewarding cooperation between Man's many religions and his sciences.

A Final Word to Fellow Researchers

To all who have been working in the field of the Electronic Voice Phenomenon, and to all who decide to now undertake serious research with the SPIRICOM concepts, we share these paragraphs:

[Taken from THE GOLDEN SCRIPTS. Material dictated telepathically from higher levels of consciousness through William Dudley Pelley, 1941. From the chapter entitled "Why Ye are Sent Unto Men."]

The hour is at hand for such knowledge to be given unto man. Behold I have chosen you for the giving of such knowledge.

Behold ye are sent unto men in this generation that they may gird their loins and be wise, taking thought to their stature in cosmic intelligence lest they dash their feet and stumble grievously.

Under my banner enroll ye, that ye may enjoy the blessings of my larder; further, these blessings come not by chance but work out a pattern determined long ago.

This pattern is twofold: it speaketh unto man on the one hand and saith, Knowledge is given you, transport it unto yourselves decorously, profit by it, use it beneficently, else it be taken from you again as it hath been taken before;

The second part of the pattern hath it that man shall have revealed unto him a vision of his heritage, that earthly things may show him the nature of his spirit.

SPIRICOM does indeed hold the promise of revealing to Man the "vision of his heritage and the nature of his spirit." From this perspective you can better understand the basis for the "Objectives of Metascience Foundation" set forth on the preceding page.

If you have read:

our illustrated booklet, THE MAGIC OF LIVING FOREVER

our technical manual, SPIRICOM

our large chart, "In Our Father's House there are Many Mansions;"

and listened to:

our cassette or phono records, "SPIRICOM--Its Development & Potential" you have been exposed to much information that is not encompassed by the sciences in which you operate. If these concepts differ so greatly from your present awareness of self and universe, that you find them emotionally or intellectually upsetting; or if you are inclined to brush them off as utter nonsense, consider the following statements. Four great scientists, each in his own way, reminded his colleagues of the need for keeping an open mind.

1. Max Planck, describing the dilemma facing science, said, "As a man who has devoted his whole life to the most clear-headed science, to the study of matter, I can tell you as a result of my research, THERE IS NO MATTER AS SUCH!"

2. Albert Einstein, on his 70th birthday said, "Now you think that I am looking back at my life's work with calm satisfaction. But, on a closer look, it is quite different. There is not a single concept of which I am convinced that it will stand firm and I am not sure if I was on the right track at all."

3. Sir Isaac Newton said, I do not know what I may appear to the world, but to myself I seem to be like a boy playing on the seashore, diverting himself in now and then finding a smoother pebble or a prettier shell than ordinary, while the great ocean of truth lay still uncovered before me."

4. Sir Arthur Eddington said, "I am standing on the threshold about to enter a room. It is a complicated business. In the first place I must shove against an atmosphere pressing with a force of fourteen pounds on every square inch of my body. I must make sure of landing on a plank traveling at 20 miles a second around the sun. I must do this while hanging from a round planet, head outward in space, and with a wind of ether blowing at no one knows how many miles a second through every interstice of my body. The plank has no solidity of substance. To step on it is like stepping on a swarm of flies. Shall I not slip through? Verily it is easier for a camel to pass through the eye of a needle than for a scientific man to pass through a door. And whether the door be a barn door or a church door, it might be wiser that he should consent to be an ordinary man and walk through, than for all the difficulties involved in a really scientific ingress to be resolved."

The above quotations make clear that at no point in time does any individual scientist, nor do sciences collectively, have "all the answers." Discoveries in the past decade by Meek and his research associates have expanded the borders of several sciences.

- - - And they might result in giving birth to an additional field of science!

METASCIENCE[®]

... combining the best insights of esoteric and spiritual lore, parapsychology, parapsysics, AND the sciences.



LET'S KEEP THIS BREAKTHROUGH IN PERSPECTIVE.....

In April 1982, SPIRICOM research is precisely where airplane research was in 1902, just a year before powered flight became a reality -- even if that first flight lasted only 12 seconds and covered only 120 feet!

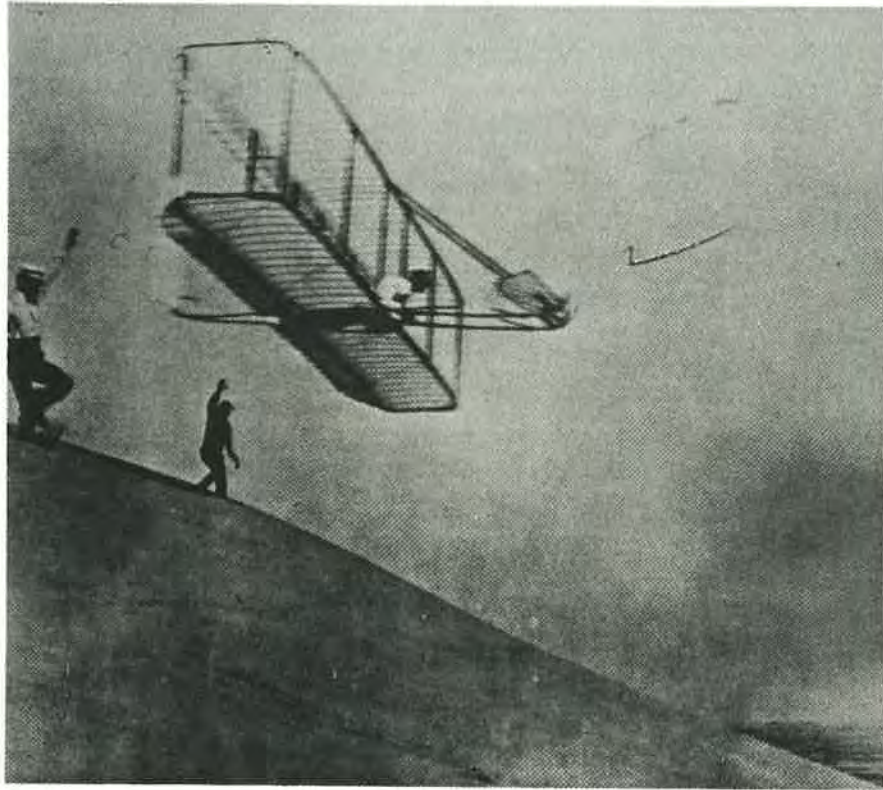

Orville Wright accomplished flight by using his **BODY ENERGIES** to "warp" the surfaces of the glider which carried him through the air.



Our Mark IV seems to be using **MIND (?) and/or PSYCHIC (?) ENERGIES** to "warp" the electromagnetic-etheric energy fields in which we and our "deceased" fellow researchers are enmeshed and in which they, as well as we, are very much alive.



As did the two Wright Brothers, the few men associated with Metascience Foundation have made the fruits of their research available without charge to inventors throughout the world.



Who is there to say that the Metascience "objectives" printed on the back of the "Many Mansions" diagram are any more of an "impossible dream" than that which burned in the heart of the Wright Brothers?

APPENDIX A

The following material is in no sense intended to be a complete statement on the subjects considered. It is presented only to stimulate the thought of any serious-minded student or scientist who might want to develop his own hypothesis as to how our two-way voice communication with Dr. Mueller is possible. An awareness of the subtle energies discussed here is essential in constructing such an hypothesis.

Considerations Regarding the Ether

History has shown time and again that important scientific discoveries generally happen only when one steps outside his regular discipline and looks at something from a fresh point of view. Then what should have been obvious all along comes into focus.

Capt. Edgar D. Mitchell
American Astronaut

While present knowledge of the nature of ether is woefully limited, we categorically state that before the modus operandi of a SPIRICOM-type of apparatus is understood, science will have to open a new window. Science must recognize that what is involved is an electromagnetic-etheric and/or electromagnetic-psychic system of communication. Only by a vast expansion of knowledge of ether and psychic energy "fields" will it be possible to move from the obviously primitive devices reported herein (Mark III and IV) to advanced systems for communication with what we currently refer to as "mental and causal planes of consciousness."

The concept of an all-pervading sea of ether has had an on-again-off-again history. In the early 19th century when the wave theory of light was postulated, a carrier seemed to be necessary and was designated as the mythical ether. This was conceived as a "fluid" penetrating all matter and being at rest in the universe, or dragged along at somewhat less speed than matter itself.

When, at the start of this century the renowned English physicist, Sir William Crookes, did serious psychic research with spiritualistic mediums and also espoused the concept of a sea of ether, he was almost ostracized by his fellow members of the Royal Academy on both counts.

Later the famed Michelson-Morley experiment was thought to have disproved the ether theory. It merely seemed to disprove the existence of a measurable ether drift -- or drag. But this deduction was as invalid as if someone today declared he had disproved the existence of the atmosphere surrounding our earth, having arrived at this conclusion because his inadequate instrumentation could not measure any wind!

Dr. H. C. Dudley in the Bulletin of the Atomic Scientists, January 1975, under the title, "Michelson's Hunch was Right," wrote:

Michelson and Morley centered their attention on the Earth's orbital velocity (30 Km/second). They had no knowledge of the existence of galaxies; of motions of galaxies in relation to each other; or the motion of our solar system in our galaxy...Their negative results are explainable on the basis of pre-1900 classical mechanics, so provide no proof of the absence of the ether or Louis de Broglie's "subquantic medium."

Thus the limited information available to Michelson and Einstein is emphasized by recent findings.

And Dr. Dudley continues:

In fact, 1929 saw Michelson still attempting to experimentally demonstrate the ether, which his intuition and reason told him ought to be present.

Today most persons are largely unaware that the ether concept began to be seriously examined by two of physics' most notable theoreticians, Paul Dirac in 1951 and de Broglie in 1959, both Nobel laureates. The ether is now being called the "nutrino sea" by astrophysicists, and has been characterized as an energy-rich particulate, subquantic medium. A rather voluminous literature on the subject is accumulating as indicated by a recent review, "The Cosmic Nutrino," with 665 references covering only the period 1965-1972... It appears that an open-minded examination of this area of physics is long overdue in order to open up new avenues of approach to this pressing problem.

Michelson, Dirac and de Broglie were not the only Nobel prize winners in favor of a reexamination of the ether question. Others were Stark, Arrhenius, A. H. Compton Lenard, H. Yukawa and Frederick Soddy, the British scientist who, during the convention of Nobel laureates in Lindau, 1954, described the current dogmas in physics as "an orgy of amateur-physics" and "arrogant swindle"--with particular emphasis on the theory of relativity. ("The Wider Aspects of Atomic Disintegration," New World Publications, St. Stephens House, Westminster S.W.1.)

It remained largely unknown, even among physicists, that Einstein himself had serious doubts. In 1949 he wrote to his old friend, Solovine, who had congratulated him on his 70th birthday.

Now you think that I am looking back at my life's work with calm satisfaction. But on closer look, it is quite different. There is not a single concept of which I am convinced that it will stand firm and I am not sure if I was on the right track after all.

A Canadian scientist in a private communication stated:

The myths around Einstein are really not of his making as he himself often questioned his own conclusions, and I felt he was quite aware of his own limitations, which others were covering up. The physicists protect their members in much the same way the medical profession protects its own.

Einstein's illustrious contemporary, Nobel prize winner Max Planck, during a lecture in Florence, Italy, once made a truly remarkable statement which describes the problem facing the physicist today:

As a man who has devoted his whole life to the most clear-headed science, to the study of matter, I can tell you as the result of my research about the atoms, this much:

THERE IS NO MATTER AS SUCH!

All matter originates and exists only by virtue of a force which brings the particles of an atom to vibration and holds this most minute solar system of the atom together... We must assume behind this force the existence of a conscious and intelligent mind. This mind is the matrix of all matter.*

This is precisely the situation that faces any contemporary scientist who attempts to investigate the fantastically complex energy problems involved in SPIRITCOM research. He will soon find it impossible to explain our repeated "loud and clear" two-way conversations with the "dead" Dr. Mueller, within the framework of the four recognized types of energy. He may also find that it is necessary to at last face up to what is now becoming known on the subject of "energy fields."

* It is of interest to observe that Meek-Tiller-McCausland were unaware of this view of Planck when in 1975 they created Fig. 18A, shown in chapter 4 of this book. If you will look at the bottom line of type you will see that this point is crucial to an understanding of the basis of holistic health and healing practices.

INFORMATION ON THE SUBJECT OF

"DIRECT VOICE"

Encyclopaedia of Psychic Science
by Nandor Fodor
University Books, 1966 Edition
(This material written about 1936)

DIRECT VOICE, an isolated voice in space without visible source of agency. It issues mostly from a trumpet which sails about the seance room in the dark and appears to serve as a condenser. With an increase of power the trumpet may be dispensed with and the voice may be heard from the centre of the floor or from any part of the room. Dennis Bradley records an experience in which the communicator began his sentence in the middle of the room, half way up he dropped the trumpet whilst his voice travelled upwards to the extreme right hand corner of the ceiling and there ended on the pronouncement of the last syllable of his last word. (*Towards the Stars*, p. 20). Physically the phenomenon requires the supposition that some material, more solid than air, is withdrawn from the medium's or from the sitter's body to produce the necessary vibrations in the surrounding atmosphere. Indeed, seance room communications speak of improvisation of a larynx. It is a strange notion. Yet the improvisation of human limbs and entire bodies is still stranger. The first vague description of a "voice box" is to be found in an out-of-body experience of Stainton Moses. He says: "I did not observe how the sound was made, but I saw in a distant part of the room near the ceiling something like a box round which blue electric light played, and I associate the sound with that." The "voice box" of Walter, Mrs. Margery Crandon's control, has been photographed as a white mass on the medium's shoulder, connected to her left ear and nostril with ectoplasmic tubes. This psychic microphone seems to be very closely associated with the medium's organism. John Watt, Mrs. Everitt's control, claimed that he used the medium's breath in speaking. If Mrs. Everitt held her hand over her mouth the volume of the voice diminished and it ceased entirely if Mrs. Everitt placed her palm on her mouth. The spirit of Cecil Husk warned Dennis Bradley not to smoke excessively on the days he was sitting as sometimes this affects the vocal organs from which part of the ectoplasmic force is taken. Archdeacon Colley describes an instance in which Dr. Monck was wakened from trance to greet a materialised fellow-student. They had to speak in turn. There was an impasse if they tried to speak at once. Bastian's direct voice was heard when his mouth was full of water, but it immediately ceased if his nose was temporarily stopped. Mrs. Everitt could never speak simultaneously with the spirits. Her lips and tongue moved but no sound was made. Other mediums felt no handicap. Signor Damiani, in his testimony before the London Dialectical Society in 1870, spoke of a seance with Home in which two voices were heard, together with the persistently speaking medium. David Duguid often spoke simultaneously. George Valiantine and Mrs. Wriedt have no difficulty in joining with the spirit voices. According to Noel Jaquin the problem consists not so much in the use of the physical voice organ, but in the co-ordination of thought. He experienced an incoherence or thinking while the direct voice was heard and could only master it by a strong mental effort. Independent conversation by two or three voices was occasionally carried on in

the seances of Mrs. Wriedt, of Detroit. J. A. Findlay reported the same with Sloan. Admiral Moore was told that the spirits seemed to speak with his voice. During the time he often felt a slight cough and irritation of the throat. Others have observed that the sitters' voices weaken if there is a prolonged direct voice conversation going on. An interesting experiment was tried with Mrs. Wriedt. She was asked to sit with seven deaf mutes from Flint, Mich. No one in the room could utter an articulate word except herself. No voices were heard.

Dr. Eugene Crowell writes of Mrs. Andrews' seances in *The Identity of Primitive Christianity and Modern Spiritualism*: "One of the common forms of manifestations at Moravia is singing by spirits. This generally occurs when the persons assembled sing with animation, the spirits seizing the moment when they are 'with one accord' raising their voices, to join in the strain, and generally the spirit voice is heard clearly above all others." He continues later: "When our spirit friends had conversed more freely than usual, the medium afterwards complained of much soreness and tenderness of the throat and lungs, evidently without any definite idea of its cause. It seemed to me that the spirits . . . were compelled to draw directly from the vocal and pulmonary organs of the medium those elements that are liberally supplied by public circles, and which are necessary for the production of spirit voices."

J. Arthur Findlay's *On the Edge of the Etheric* contains the statement of the communicators that they often make use of a psychic tube from the mouth of the medium to the trumpet. This would explain why the independent voice may resemble that of the medium and also why moisture is sometimes found within the trumpet. The spirit communicators of Findlay also gave a full description how the artificial larynx is made. It reads:

"From the medium and those present a chemist in the spirit world withdraws certain ingredients which for want of a better name is called ectoplasm. To this the chemist adds ingredients of his own making. When they are mixed together a substance is formed which enables the chemist to materialise his hands. He then, with his materialised hands, constructs a mask resembling the mouth and tongue. The spirit wishing to speak places his face into this mask and finds it clings to him, it gathers round his mouth, tongue and throat. At first, difficulty is experienced in moving this heavier material, but by practice this becomes easy. The etheric organs have once again become clothed in matter resembling physical matter, and by the passage of air through them your atmosphere can be vibrated and you hear his voice."

Findlay's explanation received confirmation two years later at a seance recorded by the Rev. V. G. Duncan in his book *Proof*. The mediums in this instance were the Misses Moore. When asked how it was possible to speak to us on earth the communicator stated:

"I can only explain it like this. You know when you have been to the dentist for an extraction and been given an anaesthetic, he puts that queer mask over your face for you to breathe the gas into your lungs. I have to use a contrivance like that in order to speak to you. This contrivance is composed of etheric matter, partly provided by the mediums and sitters, and partly supplied from our side. It is a kind of transformer, and it has a double purpose. It helps to retard my vibrations and so allows me to

make my voice audible to you and provides a temporary set of vocal organs."

Findlay's views are further enlarged upon in his second book *The Rock of Truth* (1933).

The voices may be human (sometimes of someone living. See *Control by the living*), or belong to the animal kingdom. The barking of fairly well materialised dogs, three in number, was heard by Lieut. Col. E. R. Johnson in a London seance with Mrs. Wriedt. Dennis H. Bradley in *The Wisdom of the Gods* speaks of a direct voice seance in which very loud and distinct barks were heard. "There came back an answering bark of my Alsatian wolfhound in an outhouse some distance away from the room in which the seance was being held." Mr. John M. Dick, the sporting journalist, was told that the dog was a Great Dane, in fact, his own. They had deep affection for it. This dog would always bark in four distinct barks at a time.

Technically, the process of speaking appears to be the same as the ordinary one. After a long sentence the controls often pause for breath, and the indrawing sound becomes distinctly audible. Still the phenomena may so differ individually that it is inadvisable to generalise. The vocal effects know of no restriction. The invisible communicator may laugh, whistle or sing. Walter (the control of Margery) can give expression to all sorts of moods by whistling: surprise, contentment, joy, anger and melancholy. Once, the medium and Walter laughed at the same instant. The two chuckles came from a common point in space and gave the impression of being tangled up together, as though conceivably from a common physical organism. The language may be unknown both to the medium and the sitters. Yet the nationality of the medium may have a curious influence. English, for instance, is easier spoken when the medium is English than another tongue. As an explanation it was suggested that the material to build up the artificial larynx may be drawn from the oral cavity and therefore it may be less adaptable to unusual inflexions. The experience of Dr. Abraham Wallace with John King who unexpectedly spoke to him in broad Scotch suggests a similar participation on the part of the sitter. When interrogated on the subject John King replied: "Why, I got it from you." Such indications and the bewildering variety of strange languages spoken through some mediums are mysteries, the depths of which has not been fathomed. In the Valiantine seances Portuguese, Basque, Welsh, Japanese, Russian, Hindustani and ancient pure Chinese is spoken. Dr. Neville Whyman, a famous orientalist, studied this linguistic phenomenon, and on March 25, 1927, it was also recorded on gramophone in Lord Charles Hope's apartment in London. A special telephone cable was laid on to the Columbia Gramophone Company's recording house in Petty France Street. A megaphone was connected with the recording machine and two assistants stationed outside the seance room gave the signals at various times. In the presence of Lord Charles Hope, Dennis Bradley and his wife three voices spoke in English, one in an Indian dialect, one in Hindustani, one in Italian and two in Chinese. The last one, claiming to be the voice of Confucius, was admitted by Dr. Whyman to be apparently the same as heard by him in New York.

Was Confucius actually present? Walter, when the question was put to him in Boston, explained the matter thus:

"When K'ung-fu-T'zu manifests in our seance room he is not necessarily personally present. However, at the time of Whyman's interview with K'ung-fu-T'zu

through Valiantine in trance, the Master was actually present in person."

Further light is thrown on the problem in Mrs. E. Duffey's *Heaven Revised*. In answer to her doubts as to the presence of illustrious spirits a vision was given to her:

"I beheld, or seemed to behold—for it was not sight, it was a perception as strong as the sense of seeing—a succession of links extending from sphere to sphere and from spirit to spirit, until it had finally found utterance on earth."

Archdeacon Colley heard direct voices in the darkness of the night when sleeping in the same room with Dr. Monck while holding his hand over the mouth of his sleeping companion. During an operation on Mrs. Eileen Garrett in 1931, whilst she was unconscious and gagged, the doctors in attendance heard voices in her proximity. One voice spoke glibly in a tongue which none of the doctors understood. According to Dr. Reid Clanny's account of the strange case of Mary Jobson, individuals connected with the Jobsons were sometimes accosted in their own homes by the voice which spoke in the presence of the girl and they were told to go and see her.

In the first attempts of new communicators, or when the power is insufficient, the voice is feeble or hoarse. With an increase of power or practice it becomes characteristic in tone and distinctive in enunciation. It has a conspicuous selective intelligence, always addressing itself to the right person in the right language.

As soon as the power begins to ebb the trumpet is made increasing use of. This waning of power is curiously described in Mrs. G. K. Hack's notes of the July 8, 1928, seance in Millesimo Castle: "The power suddenly failed and consequently the pronunciation of the words he used became confused and the sounds almost inarticulate, until at last they became a sort of prolonged whistle which gradually extinguished itself and formed itself into a mournful sigh."

The general strength of the voice may vary individually. Conan Doyle heard a voice in Chicago which he could only compare to the roar of a lion. Duguid's voices were usually husky. But on one occasion his speaking was so loud and harsh that the sitters became alarmed and asked the spirit to retire. Similarly, in Mrs. Robert Johnson's seances, remonstrations had to be made on account of the volume in the voice. In Mrs. Blake's case the voices were occasionally heard at the distance of one hundred feet. Kokum and Hawk Chief (Valiantine) had tremendous resounding voices. They were heard, as Dennis Bradley records, by his wife in a bedroom on the upper floor thirty to forty yards away with all the doors closed. Kokum's voice carried to a distance of two hundred yards. Mrs. Blake, Valiantine, Mrs. Wriedt, Miss Hazel Ridley and Mrs. Murphy Lydy often produced the phenomenon in full light. The usual demonstration is to shut the light out of the trumpet with the palm of the medium and hold the small end to the sitter's ear. Mrs. Lydy gave several successful platform demonstrations in this manner in May, 1931, in London.

Mr. J. B. McIndoe, of Glasgow, constructed a telephonic apparatus for the hearing of the voice in daylight. A very sensitive telephone transmitter was placed under a tightly buttoned, very high black oilskin coat, on the medium's (Andrew McCreadie) larynx. The sitters were connected with a telephone receiver through which they could hear voices in daylight. The result was the same if a trumpet was placed with

the small end under the oilskin coat on the medium's larynx. Through the large end, if closely listened to, voices came through.

Many and varied experiments have been conducted to prove the verity of the phenomenon. Ventriloquism on the medium's part offered itself as the first natural explanation. This was, however, turned down by Prof. Hyslop and Dr. Hereward Carrington in their respective experiments and was also disproved by the observations of Malcolm Bird in the Margery seances. According to Carrington at a very near range it is impossible for a ventriloquist to produce the illusion of distant sounds or voices; he must then depend upon near ventriloquism, and the nearer the listener's ear to the mouth of the performer the less perfect the illusion, until at quite close range the illusion vanishes altogether, and the sounds are correctly located, as issuing from the ventriloquist's mouth. There is no such a thing as "throwing the voice" across the room, or to any distant location in space. The voice merely seems to issue from the spot because the performer distracts the attention of his audience to it. Deprived of light to aid the view the illusion cannot be produced and the investigators who sit quite close to the medium can immediately locate the voice at its point of origin.

The medium was often asked to hold water in her mouth to see whether the voices are independent. With Mrs. Emily French, of Buffalo, the voices were tested in exacting conditions, by Prof. Hyslop, Dr. Isaac Funk and others for a full week. Findlay records how often he had his ear at Sloan's mouth when one or more voices were speaking and no sound came from it. In other experiments a special solution was used which, under the effect of the saliva, changes colour in proportion to the time during which it is held in the mouth. If one of the sitters also takes an amount into his mouth and ejects it at the same time the colour should be identical. It was by this test that Dr. Abraham Wallace contended to have established the good faith of Susannah Harris.

The Voice Control Machine, designed by Dr. Mark Richardson, of Boston, for use in the Margery seances, is a modern control apparatus. It consists of a U-shaped tube in which small luminous floats were placed on the surface of the water. By means of a flexible tube which had a specially constructed mouth-piece the medium blew into the tube and caused, by the pressure of air, the second column of water to rise. This position was retained as long as the mouth-piece was tightly held by the medium's lips and tongue. The collapse of the column of water could be immediately detected in the dark by means of the luminous floats. Yet an even more satisfactory control was devised by B. K. Thorogood; a cubical box, made of layers of seven different materials, completely sound-proof, closed and padlocked, containing a large, very sensitive microphone, connected by two wires emerging from the box to a distant loudspeaker. While sitters in the seance room heard nothing the voice of Walter issued from the loudspeaker in the distant room, proving that the voice had its origin through the "mike" in the box. Under such conditions the independence of the voices in the Margery seances was completely proved.

In direct voice communications there are two elements of the supernormal: the voice in space and the contents of the message. If it turns out that the trumpet was actually used by the medium in the dark the validity of the communication may yet be established by the other criterion. Carrington, whose

Physical Phenomena of Spiritualism describes many possibilities of fraud, points out that many investigators attend trumpet seances quite convinced that the medium does the talking. They contend that the content of the messages is the important thing.

Historically, the Davenport Brothers and Jonathan Koons, of Ohio, were the first mediums through whom direct voice phenomena were produced. It was John King who introduced it and it is also due to this romantic control that we owe the invention of the trumpet. Voice mediumship is one of the most dramatic forms of supernormal manifestations. In view of the ease with which it was acquired by Dennis Bradley one may understand his enthusiastic forecast in *The Wisdom of the Gods*: "Communication with the spirits in their actual voices may, within this century, become as simple as the telephone or wireless. In fact, it seems to me that it is a new and phenomenal form of wireless communication."

Books largely on direct voice experiences: Dennis Bradley: *Towards the Stars*; *The Wisdom of the Gods*; —And After. W. Ushborne Moore: *The Voices*; G. K. Hack: *Modern Psychic Mysteries at Millesimo Castle*; J. Arthur Findlay: *On the Edge of the Etheric*; Edward Randall: *The Dead Have Never Died*; May Wright Seawall: *Neither Dead Nor Sleeping*; J. H. Remmer: *Is Death the End?*; Clive Chapman: *The Blue Room*; Mrs. O'Hara Pincock: *The Trails of Truth*; Wilson G. Bailey: *No, Not Dead, They Live*; H. Montague Crane: *Spirit Voices*; Maurice Barbanell: *The Trumpet Shall Sound*; Bessie Clarke Drouet: *Station Astral*; Rev. V. G. Duncan: *Proof*.

APPENDIX C

Instances of Direct Voice
in the Bible

Vice Admiral Osborne Moore in 1913 reported on extensive research with the direct voice abilities of Mrs. Wreidt of Detroit during the two extended visits she made to England. (See the Bibliography.)

As a part of his literature research Admiral Moore made a very careful study of psychic phenomena in the Bible. He pointed out that it is extremely difficult to distinguish between direct voices, voices in visions and clairaudience. However, it was his opinion that most readers with any personal experience with direct voice would conclude that this phenomenon was involved in each of these instances:-

Genesis iii, 9; iv, 9; vi, 13; xii, 1-8; xvii, 1; xviii, 5; xviii, 17; xix, 2; xxi, 17; ccii, 11; xxvi, 2; xxvi, 24; xxxii, 26; xxxv, 1; xxxv, 9.

Exodus iii, 4; iv, 2; iv, 27; chs. vi-xii frequent; ch. xix; xxxiii, 9.

Numbers xii, 4; xvi, 20; xx, 7; xxii, 28.

Deuteronomy xxxi, 14; xxxiv, 4.

Joshua v, 14.

Judges vi, 12; xiii, 3.

1 Samuel iii, 4; xv, 10; xvi, 7.

2 Samuel ii, 1.

1 Kings ix, 3; xvii, 3; xix, 9-12.

Ezekiel i, 28; ii, 3.

St. Matthew iii, 17; xvii, 5; xxviii, 5; xxvii, 13.

St. Mark ix, 7; xvi, 14, 15.

St. Luke i, 13; i, 28; ii, 10; iii, 22; xxii, 43; xxiv, 5; xxiv, 17; xxiv, 36-50.

St. John xx, 13; xx, 19; xxi, 5-23.

Acts i, 11; viii, 26, ix, 4; xii, 7; xxvii, 24.

1 Corinthians xii, 10.

2 Corinthians xii, 4.

BIBLIOGRAPHY

DIRECT VOICE

- Findlay, Arthur. ON THE EDGE OF THE ETHERIC. London: Psychic Press, Ltd., 1931
- Flint, Leslie. VOICES IN THE DARK. London: Macmillan, Ltd., 1971
- Moore, Usborne. THE VOICES. London: Watts & Co., 1913
- Randall, Edward C. THE DEAD HAVE NEVER DIED. London: Geo. Allen & Unwin, Ltd., 1919
- Webster, J. H. THROUGH CLOUDS OF DOUBT. London: Psychic Book Club, 1939
- _____ NO FINALITY. London: Psychic Book Club, 1951
- _____ VOICES OF THE "PASSED" London: Psychic Book Club, 1948

ELECTRONIC COMMUNICATION WITH THE DEAD

- Bender, Peter. CARRYING ON TALKING. London: Colin Smythe, 1972 (USA ed. VOICES)
- Ellis, D. J. THE MEDIUMSHIP OF THE TAPE RECORDER. Pullborough, Eng. 1978
- Jurgenson, Friedrich. "Voice of Phenomena" in ESOTERIC, Freiberg, W. Germany
October, November, December, 1975
- Raudive, Konstantin. BREAKTHROUGH. London: Colin Smythe, 1971
- Rogo, D.S. & Bayless, R. PHONE CALLS FROM THE DEAD Englewood Cliffs, NJ:
Prentice-Hall 1979
- Rudolph, Theodor. "Electronics in Parapsychology," paper presented in Calderola,
Italy, 1974
- Sheargold, Richard K. HINTS ON RECEIVING THE VOICE PHENOMENON. Gerrards
Cross, England: Van Duren Press, 1973
- Sherman, Harold. THE DEAD ARE ALIVE. self-published 1981, Mountain View, AR 72566
- Smith, Susy. VOICES OF THE DEAD? New York: The New American Library, 1977
- Seidl, Franz. THE PSYCHOFON. Vienna, Austria, 1971
- Uphoff, Walter & Mary Jo. NEW PSYCHIC FRONTIERS: Your Key to New Worlds.
Gerrards Cross, England: Colin Smyth, Ltd. 1980
- Welch, William Addams. TALKS WITH THE DEAD. New York: Pinnacle Books, 1975

LIGHT

- Russell, Walter. THE SECRET OF LIGHT. Waynesboro, VA: University of Science
and Philosophy, 1947

NOTE: The two most helpful books on direct voice are Edward C. Randall's THE DEAD HAVE NEVER DIED and Arthur Findlay's ON THE EDGE OF THE ETHERIC. It is significant that the latter has had more than 60 printings since 1931.

METASCIENCE

FOUNDATION, INC.

RESEARCH DIVISION

**704-524-5103
P.O. BOX 747
FRANKLIN, N.C. 28734**



**HUMAN DIMENSIONS RESEARCH:
EXPLORATION OF MAN'S ENERGY FIELDS AND INTERPENETRATING SPACE-TIME SYSTEMS**

ISBN: 0-935436-05-7

\$15.00